

OJ WEB CONTROL

0661150_R03

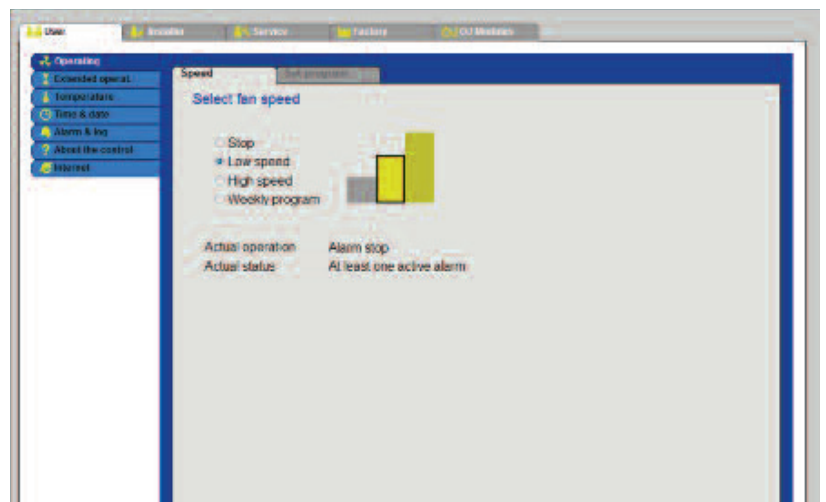



Mark air handling units are or can be provided with OJ-controls. This control system manages the entire unit. Frost protection for the counterflow heat exchanger, control of the bypass but also the control of the fans are included. This control system is extremely easy to adjust using the remote control or laptop / computer. For operation with laptop / computer, no additional software is needed. A network connection through Internet Explorer is all you need to get access. The menu structure is clear and intuitive, with different levels of access and authority.

It is possible to control the air amount on the basis of CO₂, air quality, loss of pressure or humidity. Each unit is internally fused and completely wired from the components to the isolator switch. Optional is the control of a 3-way valve for cooler, heater or battery change-over with the release of a pump.

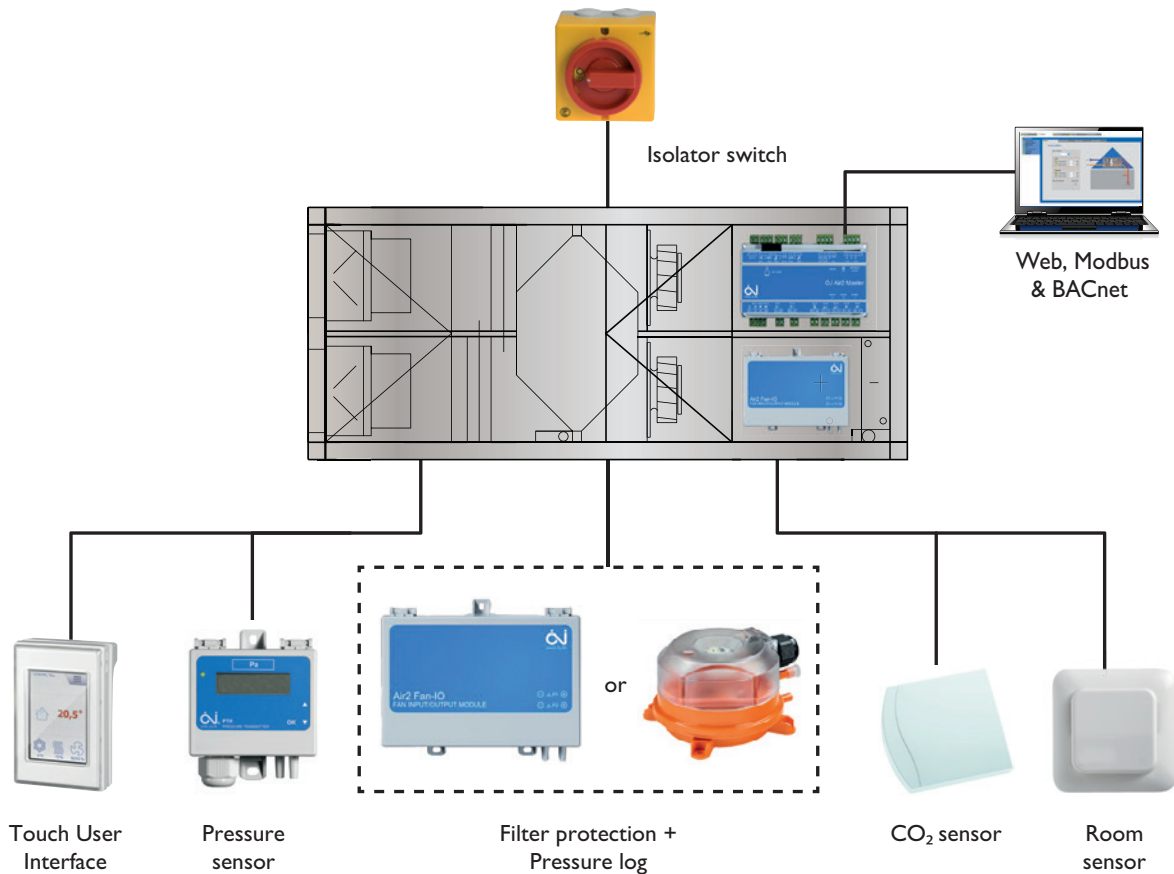



The unit can be operated with a PC or laptop. Connect the PC or laptop through a LAN cable with the master in the junction box.

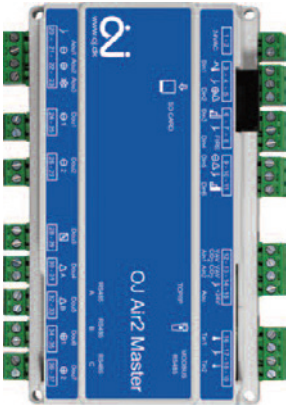

The LAN connection TCP/IP can be found on the top of the master.

Also connect the hand terminal with the connection wire in the junction box to the unit. Then put the isolation switch **“ON”**. Leave the inspection door open (watch out for the turning parts of the fan!).

Start Internet Explorer and enter the following IP Address: **192.168.1.100**

The next screen will be shown:



Enter the user name: USER

Enter the password: 111

For installer level, enter the user name: INSTALLE

Enter the password: 222

The next screen will be shown:

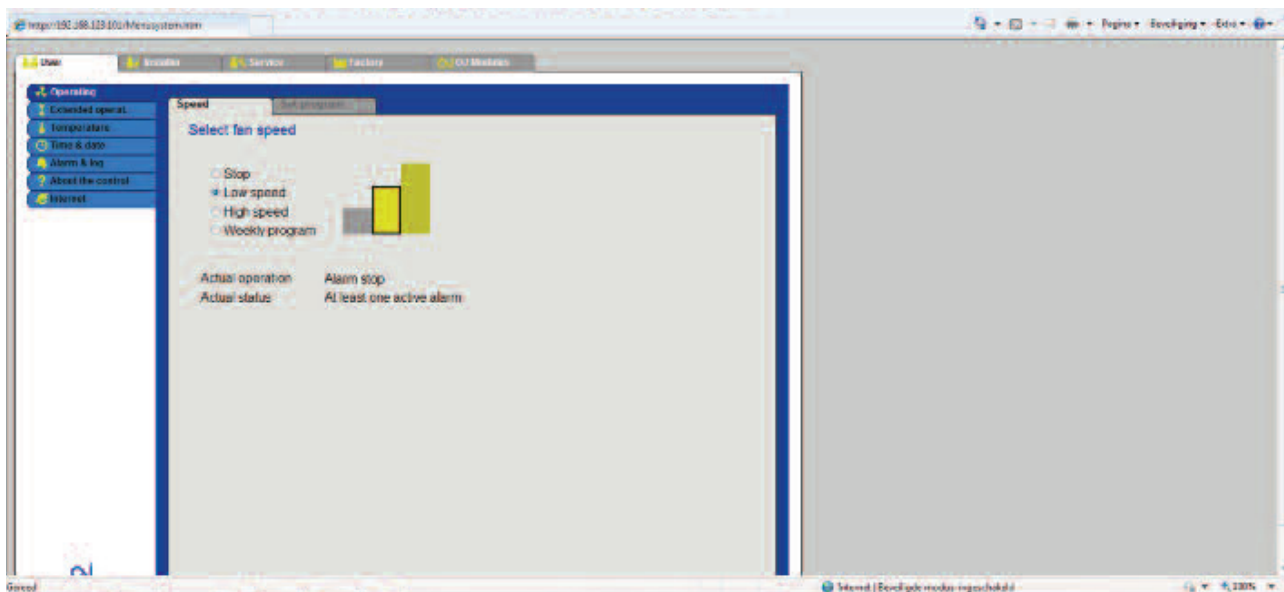

Through the tabs on the top side and left side of the screen the actual status of the unit can then be seen and possible changes can be modified. This depends on the factory installed levels. The menu structure is in general the same as the above-mentioned instructions of the hand terminal. For modifications and/or reading out actual values with pc or laptop the same instructions can be used.

Total system for HVAC

The system includes all components required for controlling fans, electric and hydronic heating coils, cooling systems, drives for rotary heat exchangers and actuators in modern air handling units.

The system components communicate via state-of-the-art bus technology while external communication is handled via standard bus systems required by the market.

The master contains a high-performance processor unit and all interfaces into and out of the system.



Web programming

Through the built-in Web server, the system is configured via a standard IE browser on a PC.

Via a multi-level user interface, the administrator can set up various levels for different groups.

All the AHU operation is performed via the unique "Push & Turn" dial on the OJ hand terminal.

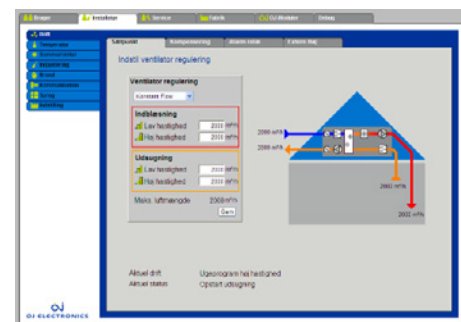

Cost-effective cabling

All peripheral units are connected to the master via a Modbus cable. This enables the system to be wired in a simple manner while retaining full control of all sub-units. This unique solution makes the system very cost-effective in installation, verification and commissioning.

The AHU can be factory assembled, including all internal installation and wiring, and can be easily unplugged and separated for transport before being reconnected on site.



Connectivity for integration in BMS systems

OJ-Air2 can be connected to a variety of systems: Modbus RTU, Modbus TCP/IP, internal Web server, BACNET.



SYSTEM COMPONENTS

Master

The OJ-AIR2 master handles all processing and communication into and out of the system. It contains various interfaces for peripheral units, allowing sensors, pumps and valves to be connected to the master.

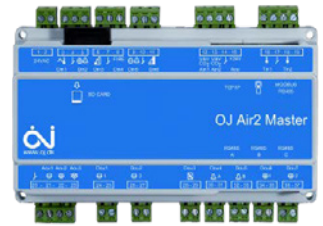

OJ-Air2-HMI-35T

OJ-Air2-HMI-35T is a user friendly user setting panel for air handling units, can be installed in connection to the air handling unit or as a room panel. OJ-Air2-HMI-35T is developed to be used together with an OJ-Air2Master.



Motorcontroller (OJ-DV)

OJ-DV Controllers do control the fanspeed and made for installation directly in the air handling unit. OJ-DV is a motor controller for both AC-IM and EC-PM motors. OJ-DV are maintenance free, extremely robust and works smoothly for years.

Fan IO

OJ Fan IOs measure air flow and perform filter surveillance. The Fan IO can also control various sensors, alarm systems and actuators for heating and cooling systems or dampers.



Power controls

OJ power controls regulate electric heating coils.

Controller for rotary heat exchanger

The DRHX controller and associated step motor regulate the rotary heat exchanger and are fully integrated via Modbus.



I/O extension

By connecting an OJ-Air2 extension module to the master via Modbus, subsidiary functions can be added to the AHU.

Sensors

OJ's extensive range of PT-1000 temperature sensors is suitable for the OJ-Air2 system.

Combined sensor for measuring humidity and temperature

HTH-620X is a series of Modbus sensors for measuring humidity (%rh) and temperature.

The sensors can be implemented in the OJ-Air2 configuration direct via Modbus RTU.



OJ-Air2-HMI-35T

Graphical OJ Air2-touchpanel

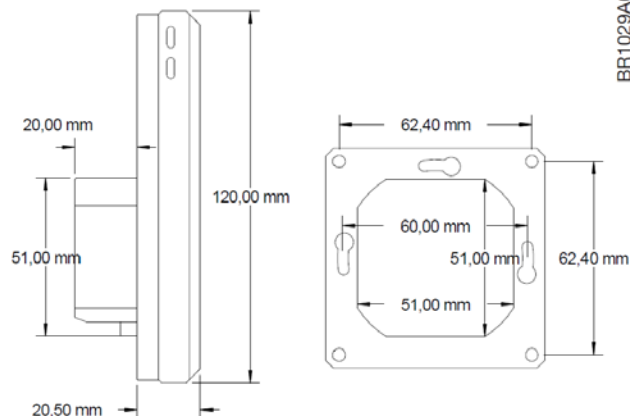

BR1029A014a

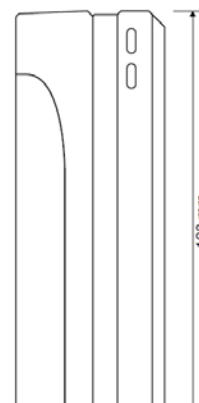

BR1029A19a

INSTALLATION

OJ-Air2-HMI-35T is to be mounted on the wall in a wall box approximately 1,5 m over the floor. Or use the from factory mounted back part, the HMI can be hand held or surface mounted onto the wall.

Cable connections to the OJ-Air2-HMI-35T are connected to the OJ-Air2Master using a Quick- Plug™ Modbus-connector and a standard tele flat cable, e.g. INEC TD6006, mounted with an standard RJ12 plug connector.

Alternative it is possible to use the screw terminals besides the RJ12 connector. The wires can be connected to the screw terminals. Cable mm2 is maximum 1,5mm2.

Technical data

- Display 3,5" TFT colour touch display
- Voltage 24 V DC $\pm 10\%$
- Power consumption $< 0,9\text{ W}$
- Electrical connecting's max. 1,5 mm², screw terminals
- QuickPlug™ Modbus 1 pcs. RJ12 (6P6C)
- Ambient temperature, running mode -10/+40 °C
- Dimensions 80 x 121 x 42 mm
- Mounting depth 22 mm
- Housing IP21
- Weight 190 g

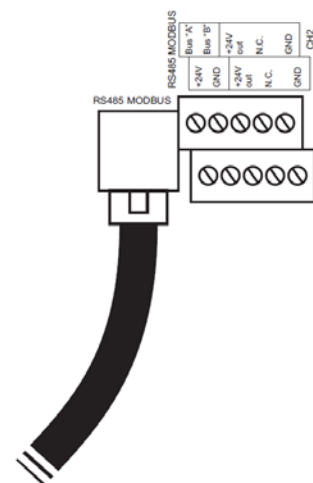

BR1029A18a

NOTE!!!

OJ-Air2-HMI-35T is implemented form SW 3.21. OJ-Air2-HMI-35T will NOT work together with earlier SW versions.

HTH-620x

Humidity and temperature sensor with Modbus

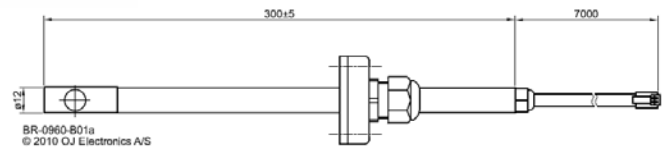
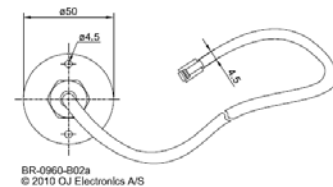

Humidity and temperature sensor with Modbus

HTH-6200 is a series of combined humidity and temperature sensors which feature Modbus communication and are ideal for measuring relative air humidity and temperature in ventilation systems.

HTH-6200 sensors are designed to be installed direct in the ventilation system ducts. Thanks to their adjustable length, the sensors are equally suitable for large and small ducting systems.

HTH-6200 is designed to provide a beneficial combination of high quality and minimum installation costs.

Minimum installation costs

With HTH-6200, air humidity and temperature can be measured and monitored by a single sensor. All data is transferred from HTH-6200 to the controller as digital values via an RS485 RTU Modbus protocol.

The built-in Modbus communication makes HTH-6200 an extremely attractive solution for integration with PLC, BMS and SCADA systems because of lower installation costs.

Telescopic sensor

To ensure correct sensor positioning within the air flow, insertion depth can be adjusted from 50 to 250 mm.

Modbus addresses

HTH-6200 is available in three variants.

All three variants are physically identical. The only difference is the way in which the products are Modbus addressed.

- HTH-6202 Modbus-adresse Hex=7A / Bin=122
- HTH-6203 Modbus-adresse Hex=7B / Bin=123
- HTH-6204 Modbus-adresse Hex=7C / Bin=124



OJ DRHX series

- Sealing grade of IP 54
- Self-cooling
- -40°C to +40°C
- Stepper motor
- 230V AC single-phase supply

Choice of size

The required motor torque depends on the actual rotor type, drive belt, ratio between the pulley and rotor diameters and desired rotor speed.

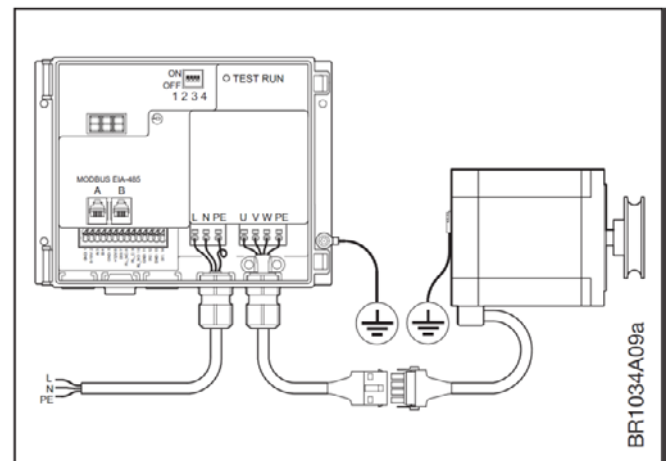
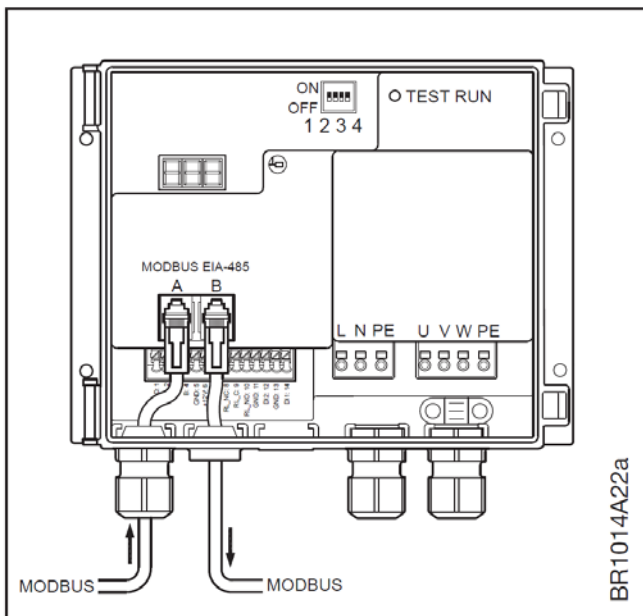

PT1000 sensors

Only PT1000 sensors can be used.

Duct sensor



PRODUCT: ETF-1098L1-0.5 / ETF-1098L1-4

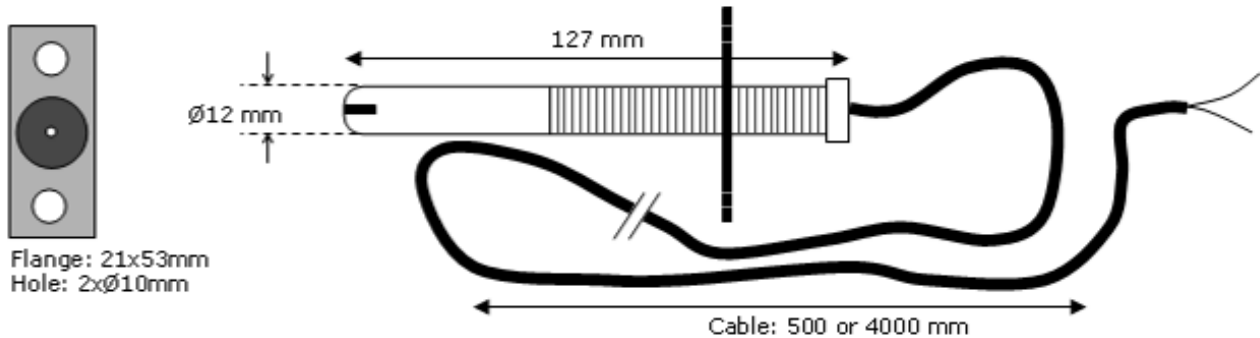

PRODUCT ID:..... ETF-1098L1-0.5
MEASUREMENTS:..... \varnothing 12mm x 127mm
CABLEDIMENSIONS:..... 500mm / \varnothing 3 / 2 x 0,25mm²

PRODUCT ID:..... ETF-1098L1-4
MEASUREMENTS:..... \varnothing 12mm x 127mm
CABLEDIMENSIONS:..... 4000mm / \varnothing 3 / 2 x 0,25mm²

PIPEMATERIAL:..... POLYCARBONATE
SENSOR:..... PT1000 / 1000 Ω @ 0°C
MEASURING RANGE:..... -40°C - +85°C
ENVIRONMENT:..... NON AGGRESSIVE AIR

Conformity of the following EC directiv(s):

- 2004/108/EC EMC DIRECTIVE
- 2006/95/EC LOW VOLTAGE DIRECTIVE

Harmonized standards :

- EN 6 1000-6-2
- EN 6 1000-6-3
- EN 60730-2-9

ETF-1098L1-0.5 & ETF-1098L1-4 MEETS THE REQUIREMENTS CONTAINED IN THE MASHINERY DIRECTIVE 89/392/EEC

-20°C = 921,6 Ω	11°C = 1042,9 Ω	16°C = 1062,3 Ω	21°C = 1081,8 Ω	26°C = 1101,2 Ω	35°C = 1136,1 Ω	60°C = 1232,4 Ω
-10°C = 960,9 Ω	12°C = 1046,8 Ω	17°C = 1066,2 Ω	22°C = 1085,7 Ω	27°C = 1105,1 Ω	45°C = 1174,7 Ω	70°C = 1270,7 Ω
0°C = 1000,0 Ω	13°C = 1050,7 Ω	18°C = 1070,1 Ω	23°C = 1089,6 Ω	28°C = 1109,0 Ω	50°C = 1194,0 Ω	80°C = 1308,9 Ω
5°C = 1019,5 Ω	14°C = 1054,6 Ω	19°C = 1074,0 Ω	24°C = 1093,5 Ω	29°C = 1112,8 Ω	55°C = 1213,2 Ω	90°C = 1347,0 Ω
10°C = 1038,8 Ω	15°C = 1058,5 Ω	20°C = 1077,9 Ω	25°C = 1097,3 Ω	30°C = 1116,7 Ω	60°C = 1232,4 Ω	100°C = 1385,0 Ω

PT1000 sensors

Only PT1000 sensors can be used.
Duct sensor/Surface sensor

PRODUCT: ETF-198B-5

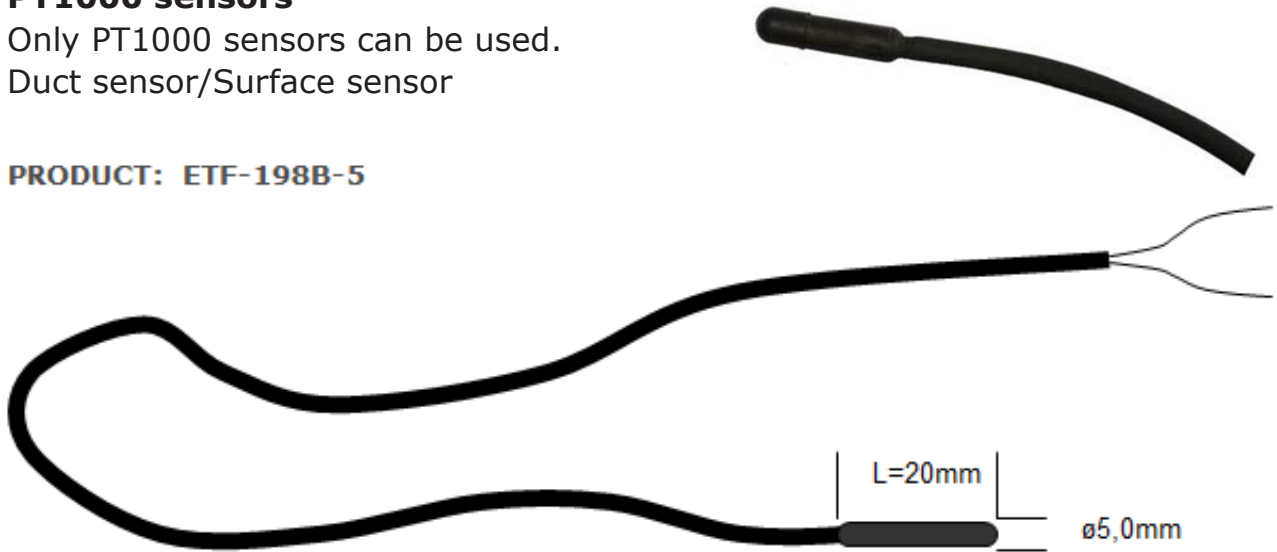

PRODUCT ID:..... ETF-198B-5
SENSOR MEASUREMENTS:..... Ø5,0mm x 20mm
CABLEDIMENSIONS:..... 5000mm / Ø3,5 / 2 x 0,25mm²
CABLETYPE.....TPE BLACK (Thermo Plastic Elastomer)
TEMPERATURE DEVIATION.....@0°C=0,3°C / @75°C=0,68°C

SENSOR:..... PT1000 / 1000Ω @ 0°C
MEASURING RANGE:.....-40°C - +150°C
ENVIRONMENT:..... NON AGGRESSIVE AIR

Conformity of the following EC directive(s):

- 2004/108/EC EMC DIRECTIVE
- 2006/95/EC LOW VOLTAGE DIRECTIVE

Harmonized standards :

- EN 61000-6-2
- EN 61000-6-3
- EN 60730-2-9

ETF-198B-5 MEETS THE REQUIREMENTS CONTAINED IN THE MASHINERY DIRECTIVE 89/392/EEC

-20°C = 921,6Ω	11°C = 1042,9Ω	16°C = 1062,3Ω	21°C = 1081,8Ω	26°C = 1101,2Ω	35°C = 1136,1Ω	60°C = 1232,4Ω
-10°C = 960,9Ω	12°C = 1046,8Ω	17°C = 1066,2Ω	22°C = 1085,7Ω	27°C = 1105,1Ω	45°C = 1174,7Ω	70°C = 1270,7Ω
0°C = 1000,0Ω	13°C = 1050,7Ω	18°C = 1070,1Ω	23°C = 1089,6Ω	28°C = 1109,0Ω	50°C = 1194,0Ω	80°C = 1308,9Ω
5°C = 1019,5Ω	14°C = 1054,6Ω	19°C = 1074,0Ω	24°C = 1093,5Ω	29°C = 1112,8Ω	55°C = 1213,2Ω	90°C = 1347,0Ω
10°C = 1038,8Ω	15°C = 1058,5Ω	20°C = 1077,9Ω	25°C = 1097,3Ω	30°C = 1116,7Ω	60°C = 1232,4Ω	100°C = 1385,0Ω

PT1000 sensors

Only PT1000 sensors can be used.
Waterbattery, surface



PRODUCT NOTE

PRODUCT: ETF-598B-5

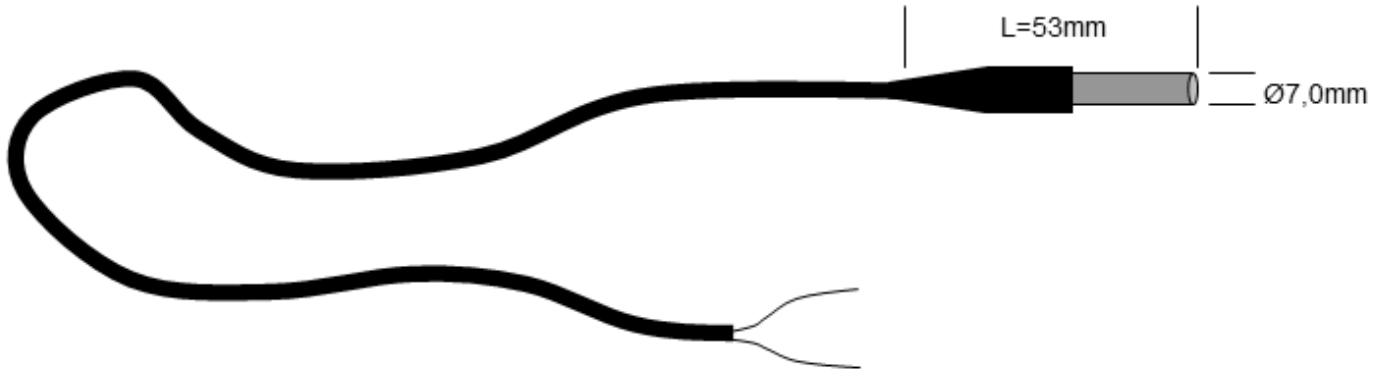

PRODUCT ID:..... ETF-598B-5
SENSOR MEASUREMENTS:..... Ø7,0mm x 53mm
SENSORMATERIAL..... STAILLESS STEEL AISI316
CABLEDIMENSIONS:..... 5000mm / Ø3,5 / 2 x 0,25mm²
CABLETYPE..... TPE BLACK (Thermo Plastic Elastomer)
TEMPERATURE DEVIATION.....@0°C=0,3°C / @75°C=0,68°C

SENSOR:..... PT1000 / 1000Ω @ 0°C
MEASURING RANGE:.....-40°C - +150°C
ENVIRONMENT:.....AGGRESSIVE AIR AND LIQUIDE

Conformity of the following EC directive(s):

- 2004/108/EC EMC DIRECTIVE
- 2006/95/EC LOW VOLTAGE DIRECTIVE

Harmonized standards :

- EN 61000-6-2
- EN 61000-6-3
- EN 60730-2-9

ETF-598B-5 MEETS THE REQUIREMENTS CONTAINED IN THE MASHINERY DIRECTIVE 89/392/EEC

-20°C = 921,6Ω	11°C = 1042,9Ω	16°C = 1062,3Ω	21°C = 1081,8Ω	26°C = 1101,2Ω	35°C = 1136,1Ω	60°C = 1232,4Ω
-10°C = 960,9Ω	12°C = 1046,8Ω	17°C = 1066,2Ω	22°C = 1085,7Ω	27°C = 1105,1Ω	45°C = 1174,7Ω	70°C = 1270,7Ω
0°C = 1000,0Ω	13°C = 1050,7Ω	18°C = 1070,1Ω	23°C = 1089,6Ω	28°C = 1109,0Ω	50°C = 1194,0Ω	80°C = 1308,9Ω
5°C = 1019,5Ω	14°C = 1054,6Ω	19°C = 1074,0Ω	24°C = 1093,5Ω	29°C = 1112,8Ω	55°C = 1213,2Ω	90°C = 1347,0Ω
10°C = 1038,8Ω	15°C = 1058,5Ω	20°C = 1077,9Ω	25°C = 1097,3Ω	30°C = 1116,7Ω	60°C = 1232,4Ω	100°C = 1385,0Ω

User settings

Setting user functions

Operating

Setting operating times and weekly program.

Speed

Select fan speed

- √ **"Stop"** = the system is stopped.
 - Safety functions are active.
 - Intake and exhaust dampers are closed.
- √ **"Low speed"** = the system runs constantly according to the parameter settings for low speed.
 - Operating times for the weekly program cannot be accessed.
- √ **"High speed"** = the system runs constantly according to the parameter settings for high speed.
 - Operating times for the weekly program cannot be accessed.
- √ **"Weekly program"** = the system runs according to the weekly program settings.
 - Operating times for the weekly program can now be accessed and set.

🌈 When the system is stopped in accordance with the programmed times, it can be started automatically in accordance with the settings for "minimum night temperature" and "summer night cooling", and if the digital input for "High speed" is activated, the system will run for the set length of time.

NOTE! – when the AHU is stopped according to the Weekly program

- The system can start automatically according to the settings for "Min. night temperature" and the settings for "Summer night cooling".
- If "Recirculation" is selected for night-time heating, the system will start according to the minimum night temperature set under Installer/Temperature/Recirculation.
- If "Summer night cooling" is selected, the system will start according to the parameters for summer night cooling set under Installer/Temperature/Summer night.
- If the "High speed" digital input is activated, the system will start and run for the time set. The run-on time is set under: "Installer > Operating > External high"

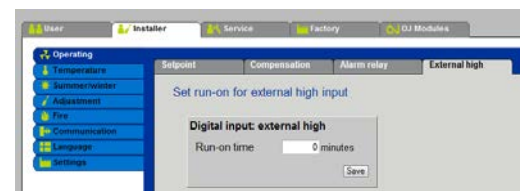
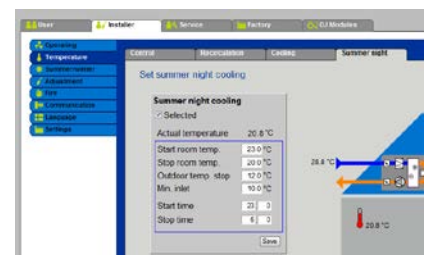
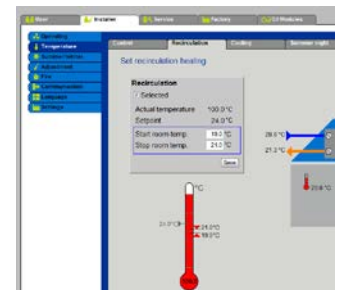
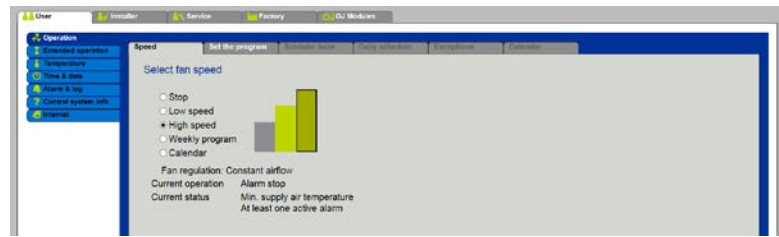

SFP for supply- and exhaustfan

Specific

SFP for supply- and exhaustfan

Specific Fan Power (Energy consumption per m3 air moved) Only supported with OJ-DV..!!

User settings

Setting user functions

Operating

Setting operating times.

Speed

A maximum of
4 start times and 4 stop times can be set per day

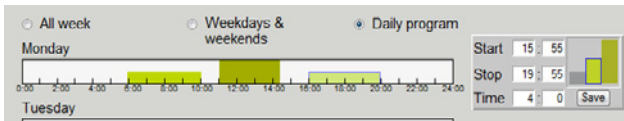

All week

- ✓ The same schedule is used on all days of the week

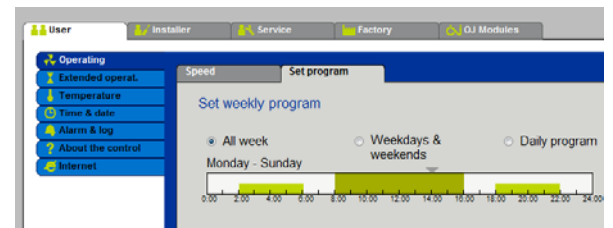
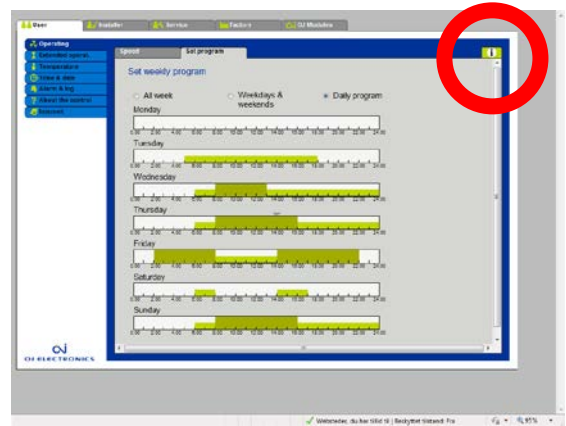

Weekdays & weekends

- ✓ One schedule is used on weekdays
- ✓ Another schedule is used on Saturdays and Sundays

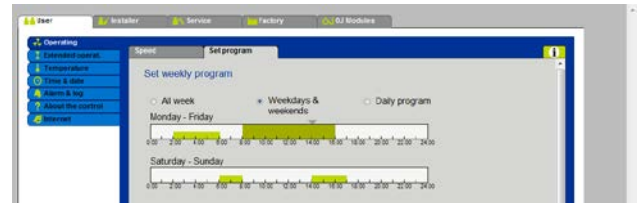

Daily program

- ✓ A separate schedule is used on each day of the week

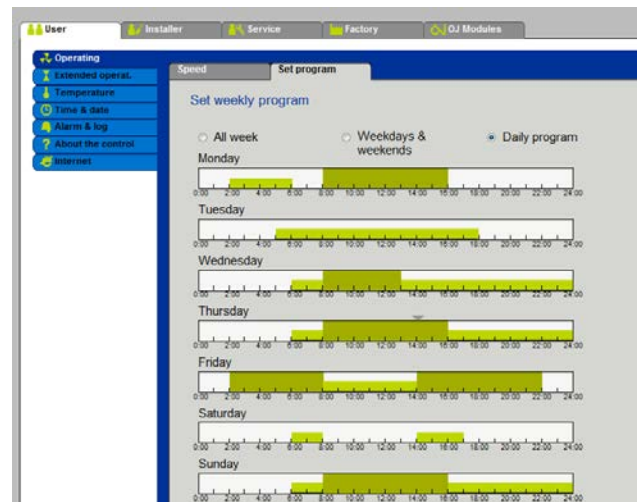

User settings

Setting user functions

Operating

Setting operating times.

To create a new operating period:

- ✓ Click the white area on the day an operating period is to be created.

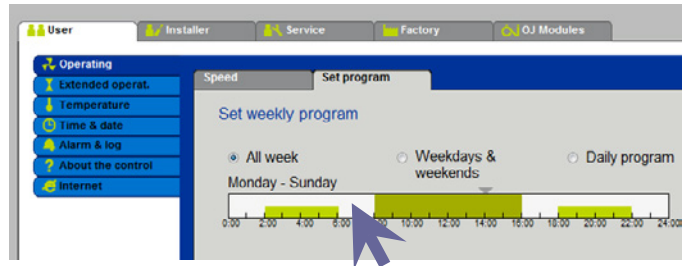

- ✓ The settings window now allows start and stop times to be set.

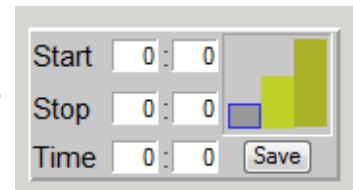

- ✓ Select the required operating type by clicking "grey", "light green" or "dark green".

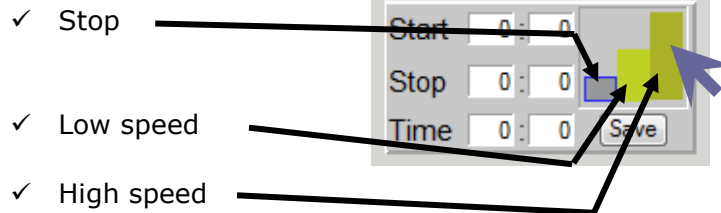

- ✓ Set the start and stop times for the required operating type.

- ✓ Finish with "Save".

3 steps – 3 setpoints

If you want to use 3-step setpoint control, you must select "Medium fan speed" under:

"OJ-Modules > Configure > Settings".....>>>

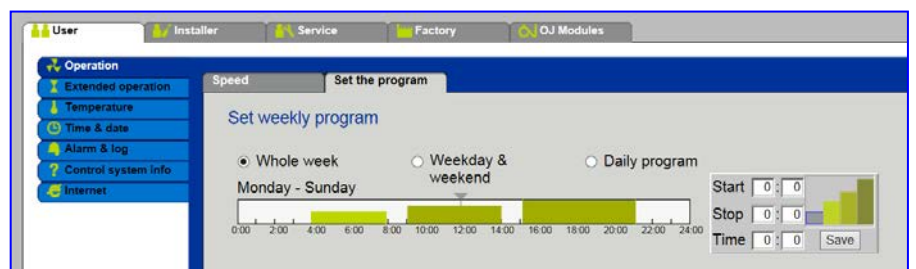
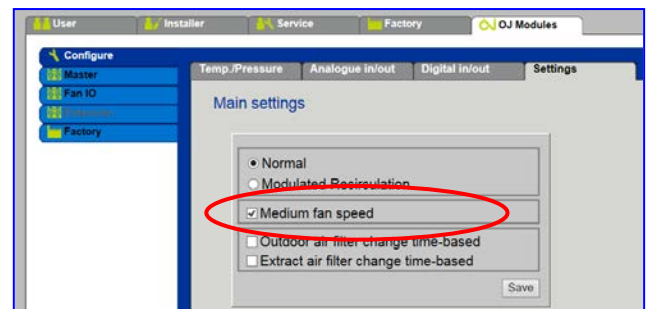

User settings

Setting user functions

Calendar function (Year clock function)

Setting up calendar program.

Introduction

The calendar program makes it possible to configure operating times for a year or more.

In the calendar program, an operating pattern can be configured for how the system should run during normal operation.

Special operation modes can be preprogrammed in connection with holiday periods, festivals, national holidays, extraordinary open days, etc.

The function can for example be used advantageously at schools where there are fixed periods for normal operation, holiday periods and extraordinary open or closed days.

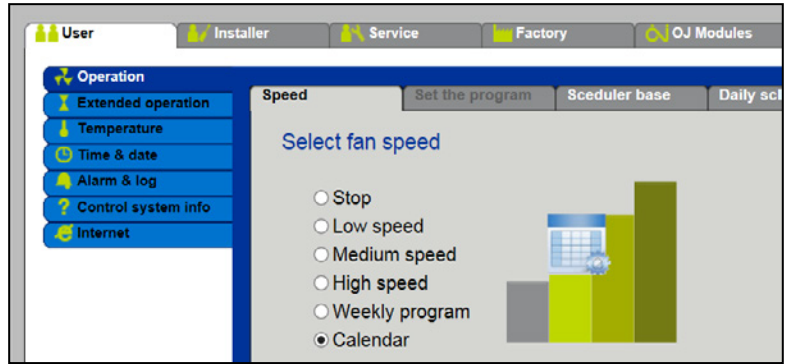

To activate the calendar program:



When "Calendar" has been activated, the associated tabs then become available for setting the calendar program.

Basic program

The first thing that should be configured is the "Basic program" which comprises the operation mode the system will assume when it is out of operation, for example during the night, during holidays or other periods involving stopped operation. The period during which the basic program applies is selected here.

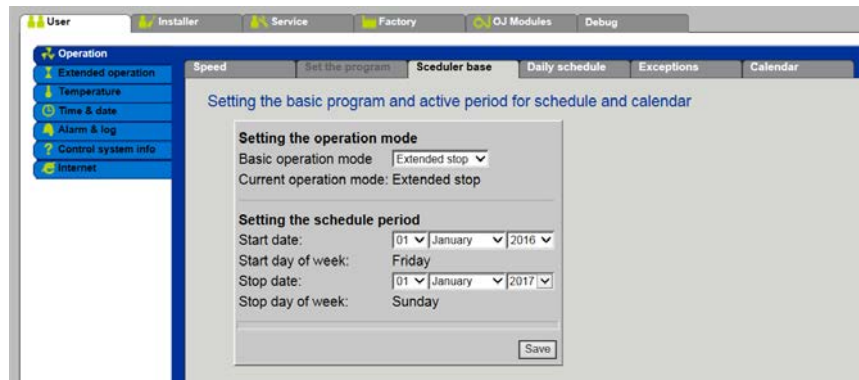

Setting the operation mode

Select the operation mode the system will assume when it is out of operation, for example during the night, during holidays or other periods involving stopped operation.

- ✓ **Stop:** The system is stopped. Frost protection as well as other safety functions remain active.
- ✓ **Low speed:** The system will operate as per the settings for "Low speed".
- ✓ **High speed:** The system will operate as per the settings for "High speed".
- ✓ **Extended stop:** The system is stopped. Functions such as "Summer night cooling (free cooling) and minimum night temperature are active and the system will start automatically when the operating conditions for these functions are fulfilled. The system may also be started via "Extended operation" or other override functions. Frost protection of the water heating coils as well as other safety functions remain active.

Setting the schedule period

- ✓ Specify via the *start date* and *end date* when the **Daily schedule** and **Exceptions** are active.
- ✓ The basic operation mode will be in effect automatically during periods outside the basic program's *start date* and *end date*.

User settings

Setting user functions

Calendar function (Year clock function)

Setting up calendar program.

Example of programming of calendar program (year clock)

We will use the example below in order to describe the possibilities of the calendar function.

The example below describes **a school**, where as a point of arrivals and departures all Mondays are identical, all Tuesdays are identical.....all Saturdays are identical, all Sundays are identical.

Mondays:

1. **6:00 am** the school opens for cleaning and preparations, with the system starting at low speed.
2. **8:00 am** the first pupils arrive and the system switches to medium speed.
3. **9:00 am** all pupils have arrived and the system switches to high speed.
4. **3:00 pm** the first pupils start to leave the building and the system switches to medium speed.
5. **5:00 pm** the cleaning starts and the system switches to low speed.
6. **7:00 pm** the system is stopped for the day.

Tuesday....Thursday: same as Monday.

Fridays:

1. **6:00 am** the school opens for cleaning and preparations, with the system starting at low speed.
2. **8:00 am** the first pupils arrive and the system switches to medium speed.
3. **9:00 am** all pupils have arrived and the system switches to high speed.
4. **2:30 pm** the cleaning starts and the system switches to low speed.
5. **5:00 pm** the system is stopped for the day.

Saturdays

8:00 am the school's library is open and the system starts up at medium speed.

3:00 pm the system is stopped for the day.

Sundays: The system is stopped during the entire day

During those periods when the system is stopped, *summer night cooling* and *night-time heating* will monitor the room's temperature and the system will start when the conditions for it to do so are fulfilled.

The above operating pattern entered as a weekly program. >

On the next page, the same operating pattern is configured in the calendar program with exceptions.

We will review how deviations from the fixed weekly program are configured, such as holiday periods, national holidays, extraordinary open days as well as other extraordinary exceptions.

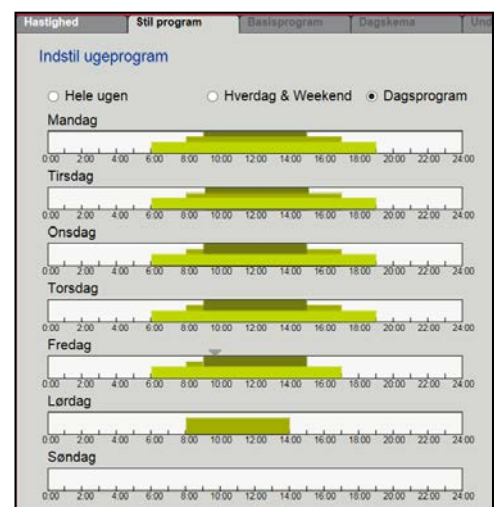

User settings

Setting user functions

Calendar function (Year clock function)

Setting up calendar program.

Setting standard operating pattern

Setting the operation mode:

The basic program should be configured first. "Setting the operation mode" comprises the operation mode that the system will assume when the calendar

program is outside the configured operation periods as per the daily schedule and the exceptions, holiday periods, etc., that have also been set up.

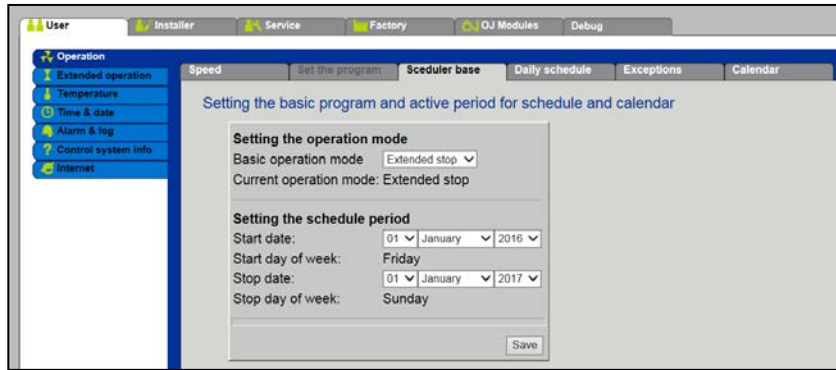

✓ Stop

- The system is stopped outside the configured operation periods. Frost protection of heating coils remains active and pump and valve motioning also remains active.

✓ Low - the system will run on low speed outside the configured operation periods.

✓ Medium - the system will run on medium speed outside the configured operation periods.

✓ High - the system will run on high speed outside the configured operation periods.

✓ Extended stop – the system will be stopped outside the configured operation periods.

However:

- The system is stopped outside the configured operation periods. Frost protection of heating coils remains active and pump and valve motioning also remain active.
- Summer night cooling will be active and the function will start the system if the preconditions for doing so are fulfilled.
- Minimum night temperature will be active and the function will start the system if the preconditions for doing so are fulfilled.
- The system can be started manually via the start signal: "High speed".

Setting the schedule period

*1:

Set the period during which the calendar program will be active.

Here, we have selected "Setting the schedule period" = **1 January 2016....1 January 2017**

*2:

Outside this period, the selected operation mode as configured under "Setting the operation mode" will be active.

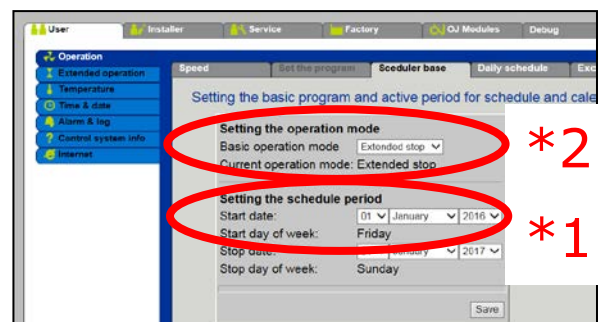

Here, we have selected "Operation mode" = **Extended stop**

User settings

Setting user functions

Calendar function (Year clock function)

Setting up calendar program.

Setting standard daily operating pattern

For setting the operating pattern that will be in effect as the standard periods in which the system is to run in normal operation.

Select "Daily schedule" and in the dialogue box "Select day" choose pattern for Mondays.

In our example, as described earlier, the points in time are now set its status on Mondays.

Next to each individual time for changing the operation mode, select the mode that the system will assume at this selected time.

Operation modes can be selected as:

- ✓ **Stop**
 - The system is stopped outside the configured operation periods. Frost protection of heating coils remains active and pump and valve motioning also remains active.
- ✓ **Low** - the system will run on low speed outside the configured operation periods.
- ✓ **Medium** - the system will run on medium speed outside the configured operation periods.
- ✓ **High** - the system will run on high speed outside the configured operation periods.
- ✓ **Extended stop** - the system will be stopped outside the configured operation periods.

However:

- The system is stopped outside the configured operation periods. Frost protection of heating coils remains active and pump and valve motioning also remain active.
- Summer night cooling will be active and the function will start the system if the preconditions for doing so are fulfilled.
- Minimum night temperature will be active and the function will start the system if the preconditions for doing so are fulfilled.
- The system can be started manually via the start signal: "High speed"

If the operating patterns are identical for Monday through Friday, then use the "Copy" button.

Monday: Weekdays

- ✓ The same time schedule that has now been specified as the operating pattern for Mondays will be copied to all weekdays, i.e. Monday....Friday



Monday: Entire week

- ✓ The same time schedule that has now been specified as the operating pattern for Monday will be copied to all days.

NOTE: Copying functionality..!

If there are individual days that are not going to have the same operating pattern even though you have used the copying functionality, then these days can subsequently be individually changed.

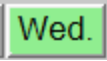
Colours of buttons

-  Light grey: Selected weekday that can be configured under the time schedule
-  Green: At least one activity has been programmed for this day
-  Dark grey: There are no programmed activities for this day

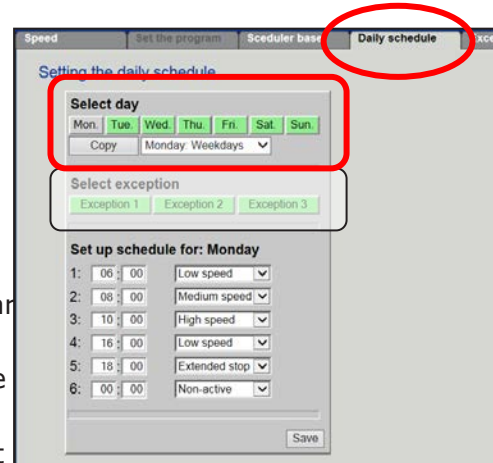

User settings

Setting user functions

Calendar function (Year clock function)

Setting up calendar program.

Setting exceptions

You should now configure the exceptions from the normal operating pattern.

As a primary rule, we recommend that you configure those exceptions that are of the shortest duration as the first exceptions and those with the longest duration as the last exception(s).

If for example we assume that there are the following exceptions, in relation to the normal daily schedule:

- ✓ During the periods and days below, the system will assume the operation mode: "Extended stop"

1 January is a closed day = 1 closed day

Week 7 is holiday = 5 closed days

24-28 March is Easter = 5 closed days

22 April is a national holiday = 1 closed day

5-8 May are national holidays = 4 closed days

25 June - 7 August are summer holidays = 44 closed days ^{1)*}

Week 42 are autumn holidays = 4 closed days ^{2)*}

22-31 December are Christmas holidays = 10 closed days

1)*

There is, however, one exception from the above, namely on the Wednesday of the first week of the summer holidays.

The school will be open at that time for volunteer work and the system will hence run with respect to the following operating pattern:

29 June the school will be open for volunteer work and will run at low speed from 8:00 am to 6:00 pm.

2)*

During the autumn holidays, the school will be open for a homework café on Wednesday

19 October for all pupils and the system must hence run at medium speed from 8:00 am to 2:00 pm.

...continued on following page...

User settings

Setting user functions

Calendar function (Year clock function)

Setting up calendar program.

Setting exceptions

The exceptions should be configured now. As mentioned previously, it is advantageous to configure the shortest periods first as exceptions 1 or 2.

So we will now choose to configure:

Exception 1

- for the operation mode that you will use on that individual day during the summer holidays on which the system must run at low speed from 8:00 am to 6:00 pm.

The screenshot shows the 'Setting the daily schedule' interface. The 'Daily schedule' tab is selected and circled in red. Under 'Select day', 'Monday Weekdays' is chosen. In the 'Select exception' section, 'Exception 1' is selected and circled in red. The 'Set up schedule for: Exception 1' section is also circled in red and contains the following data:

Time	Mode
1: 08:00	Low speed
2: 18:00	Extended stop
3: 00:00	Non-active
4: 00:00	Non-active
5: 00:00	Non-active
6: 00:00	Non-active

Exception 2

- for the operation mode that you will use on that individual day during the autumn holidays on which the system must run at medium speed from 8:00 am to 2:00 pm.

The screenshot shows the 'Setting the daily schedule' interface. The 'Daily schedule' tab is selected and circled in red. Under 'Select day', 'Monday Weekdays' is chosen. In the 'Select exception' section, 'Exception 2' is selected and circled in red. The 'Set up schedule for: Exception 2' section is also circled in red and contains the following data:

Time	Mode
1: 08:00	Low speed
2: 14:00	Medium speed
3: 00:00	Non-active
4: 00:00	Non-active
5: 00:00	Non-active
6: 00:00	Non-active

Exception 3

- for the operation mode that you will use on all days on which the system must be stopped.
- Here, "Extended stop" is selected in order for the system to start up automatically if the conditions for starting up night-time heating are fulfilled. The system will also start up if the conditions for starting up free cooling are fulfilled.

The screenshot shows the 'Setting the daily schedule' interface. The 'Daily schedule' tab is selected and circled in red. Under 'Select day', 'Monday Weekdays' is chosen. In the 'Select exception' section, 'Exception 3' is selected and circled in red. The 'Set up schedule for: Exception 3' section is also circled in red and contains the following data:

Time	Mode
1: 00:00	Extended stop
2: 00:00	Non-active
3: 00:00	Non-active
4: 00:00	Non-active
5: 00:00	Non-active
6: 00:00	Non-active

You have now configured the operation mode for: "Exception 1", "Exception 2", "Exception 3",

On the next page, you will configure when these exceptions will be active.

User settings

Setting user functions

Calendar function (Year clock function)

Setting up calendar program.

Setting exceptions

Precisely when the exceptions will be active will now be configured.

Exception 1

Must be active on the individual day of

29 June 2016

during the summer holidays when the system is to run at low speed from 8:00 am to 6:00 pm.

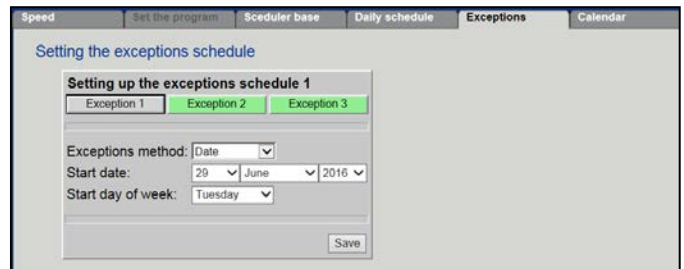

The screenshot shows a software interface with a menu bar containing 'Speed', 'Set the program', 'Scheduler base', 'Daily schedule', 'Exceptions', and 'Calendar'. Below the menu bar, the title 'Setting the exceptions schedule' is displayed. A dialog box titled 'Setting up the exceptions schedule 1' is open, showing three tabs: 'Exception 1', 'Exception 2' (which is selected and highlighted in green), and 'Exception 3'. The 'Exceptions method' is set to 'Date'. The 'Start date' is configured as '29 June 2016' using dropdown menus. The 'Start day of week' is set to 'Tuesday'. A 'Save' button is located at the bottom right of the dialog box.

Exception 2

Must be active on the individual day of

19 October 2016

during the autumn holidays when the system is to run at medium speed from 8:00 am to 2:00 pm.

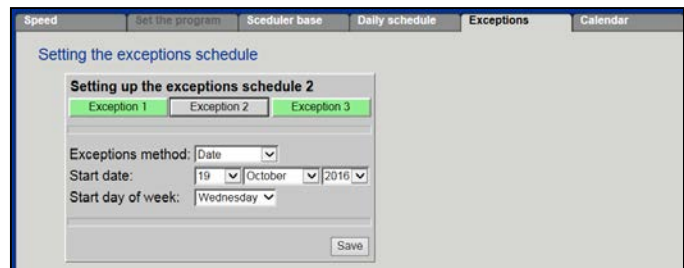

The screenshot shows the same software interface as above. The dialog box is now titled 'Setting up the exceptions schedule 2'. The 'Exception 2' tab is selected and highlighted in green. The 'Exceptions method' is 'Date', the 'Start date' is '19 October 2016', and the 'Start day of week' is 'Wednesday'. A 'Save' button is at the bottom right.

Exception 3

Here, select "Calendar" for the operation mode that you will use on all days on which the system must be stopped.

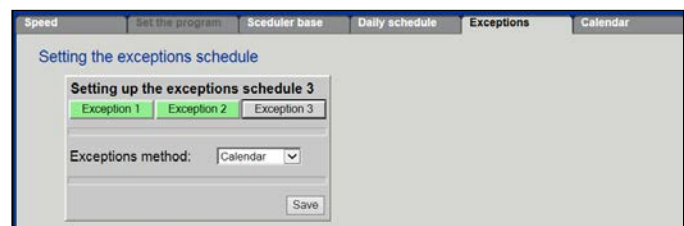

The screenshot shows the same software interface. The dialog box is titled 'Setting up the exceptions schedule 3'. The 'Exception 3' tab is selected and highlighted in green. The 'Exceptions method' is set to 'Calendar'. A 'Save' button is at the bottom right.

You have now configured when: "**Exception 1**", "**Exception 2**" and "**Exception 3**" will be active.

On the next page, you will configure the "Calendar" for **Exception 3**.

User settings

Setting user functions

Calendar function (Year clock function)

Setting up calendar program.

Setting up calendar

You will now configure when **Exception 3** will be active.

Setting up calendar 1

Configure the first period on the calendar in which

Exception 3 - must be active

NOTE!

Exception 3 was of course the exception that under "Exceptions" was configured to follow the "Calendar"

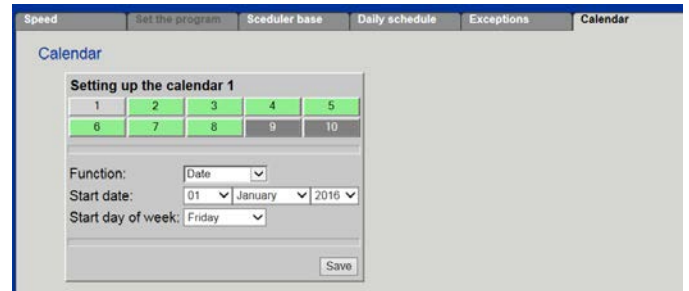

Possible choices: Setting up calendar

✓ Date

- Set a date on which "Exception 3" will be active.
- Remember to configure "Start day of week" correctly.

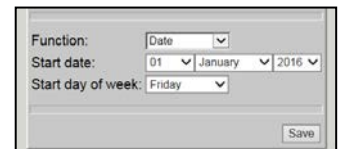

✓ Date range

- Set a date range during which "Exception 3" will be active.
- Stop day of week will be set automatically and will show the last weekday in the selected period on which "Exception 3" will be active.

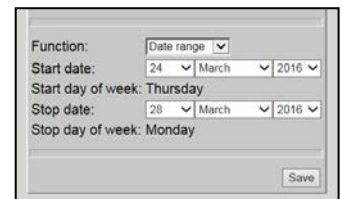

✓ Day of week

- Set a weekday on which "Exception 3" will be active.
 - Start date: "1-7" = The first week of the selected month
 - Start date: "7-14" = The second week of the selected month
 - Start date: "14-21" = The third week of the selected month
 - Start date: "21-28" = The fourth week of the selected month
 - Start date: "29-31" = The fifth week of the selected month
 - Last 7 days: The last week of the selected month
- Configure month in which the period will be active: January.....December
- Configure the weekday during the period selected above on which "Exception 3" will start being active.

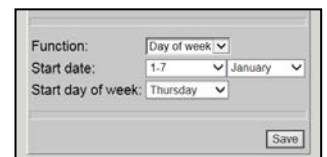

Configure all periods in this manner for which the calendar program should activate **Exception 3**.

User settings

Setting user functions

Calendar function (Year clock function)

Setting up calendar

Display in BACnet Explorer (Inneasoft) *Licensed product*

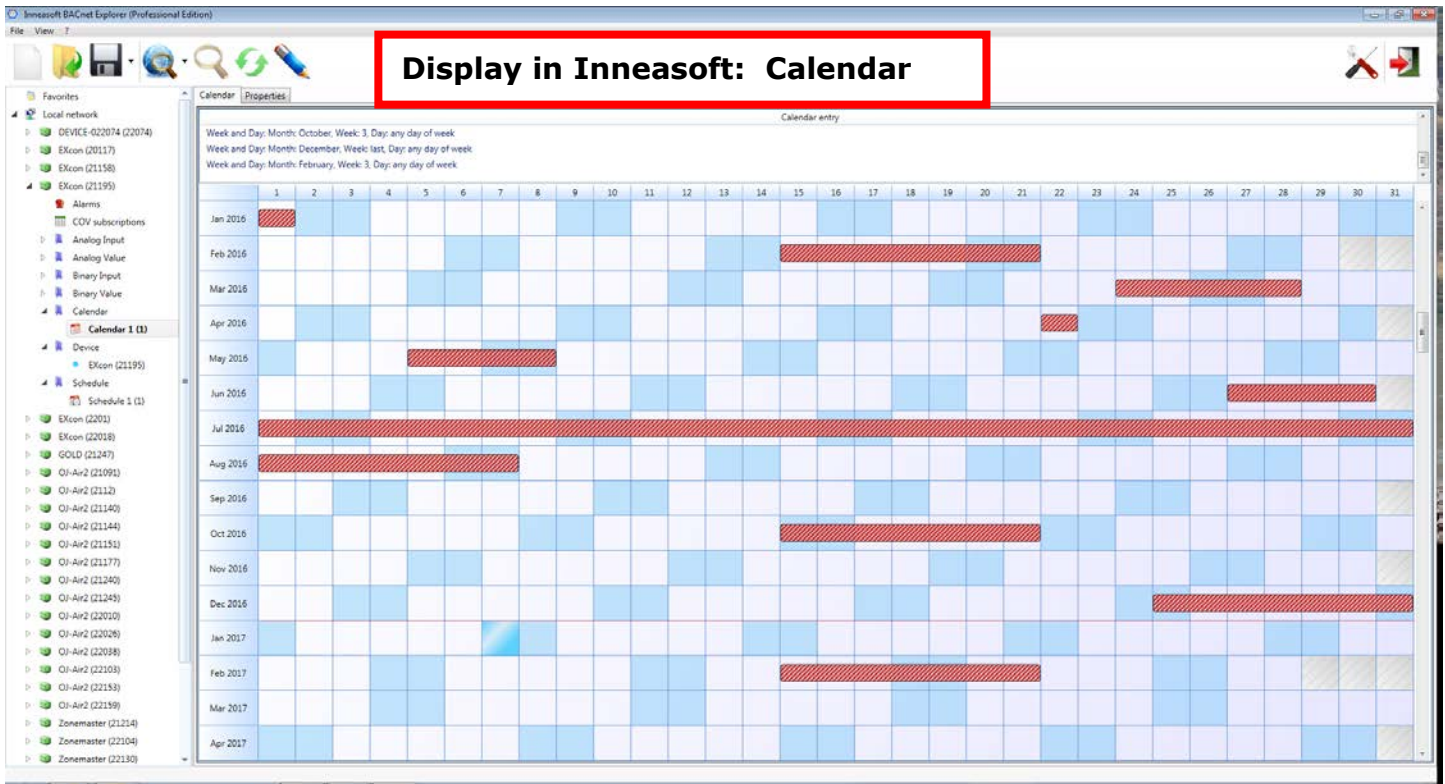
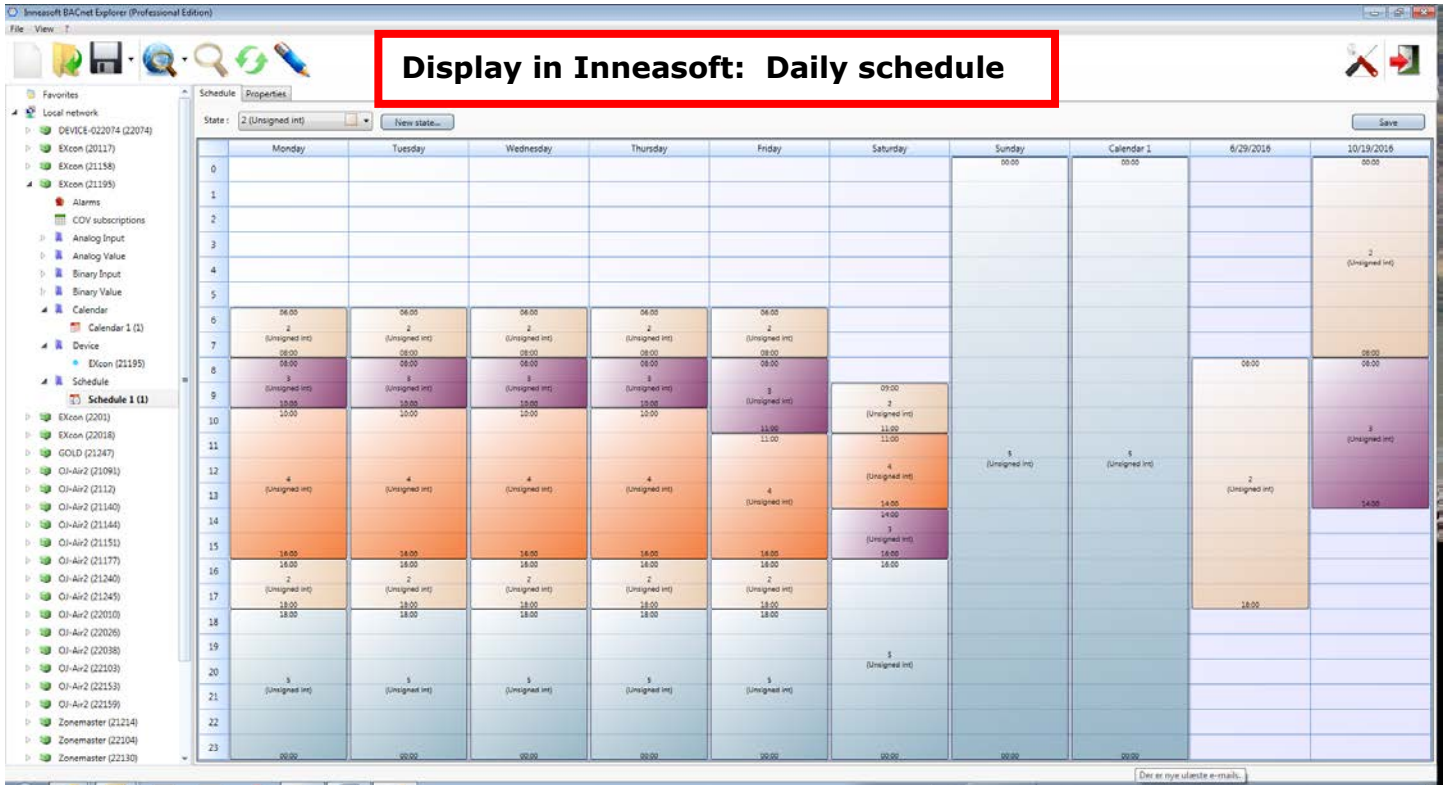

User settings

Setting user functions

Extended operation

Setting a period of extended operation

To create a new operating period:

Extended operation

The extended operation function overrides the ventilation control settings for a specified period. The weekly program is temporarily suspended while extended operation is active.

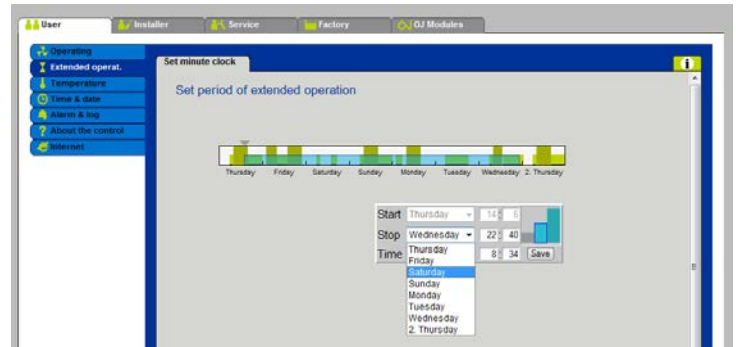

Starting extended operation

1. Click the white area of the week calendar.
2. Select speed by clicking one of the columns in the pop-up window.
 - Light blue column: Low speed
 - Dark blue column: High speed

For each day, the period of operation is indicated in the white area as a rectangle in the colour selected.

To change the stop time for extended operation, move the right-hand end of the rectangle using the mouse.

3. Alternatively, enter the required times in the pop-up window.
4. Click the Save button.

Stopping extended operation

1. On the white area of the week calendar, click the period of operation (the rectangle) to be deleted.
2. Delete the selected period of operation by clicking the grey column in the pop-up window.
3. Click the Save button.

Changing the period of extended operation

1. On the white area of the week calendar, click the period of operation (the rectangle) to be changed.
2. To change the stop time for extended operation, move the right-hand end of the rectangle using the mouse.
3. Alternatively, enter the required times in the pop-up window.
4. Click the Save button.

Changing speed

1. Click the white area of the week calendar.
2. To change the speed for the selected period of operation, click one of the columns in the pop-up window.
 - Light blue column: Low speed
 - Dark blue column: High speed
3. Click the Save button.

User settings

Setting user functions

Temperature setpoint

The setpoint described in this section is always the temperature setpoint for the control type selected.

The selected control type is displayed here.

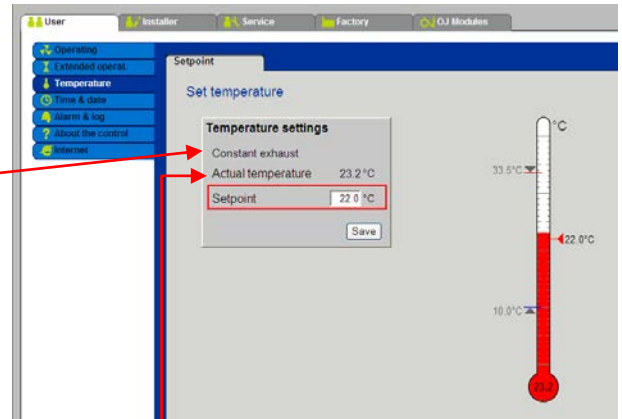

Control type is selected under:

- ✓ "Installer > Temperature" and can be selected to:
- ✓ "Constant inlet".....Supply air temp. is displayed
- ✓ "Constant extract" ".....Exhaust air temp. is displayed
- ✓ "Constant room".....Room air temp. is displayed
- ✓ "Constant supply/exhaust diff."...Supply air temp. is displayed

Changing the temperature setting (temperature setpoint):

Values can be changed by entering a new value in the data-entry field or by moving the mouse onto the value beside the thermometer, pressing the left-hand mouse button, moving the value and releasing the left-hand mouse button beside the required value.

Finish with "Save".

User settings

Setting user functions

Time and date

- ✓ Set actual "Year"
- ✓ Set actual "Month"
- ✓ Set actual "Date"
- ✓ Set actual "Week day"
- ✓ Select automatic summer/winter time changeover if wanted
- ✓ Set actual "Time"
- ✓ Or retrieve the current "time and date" from a connected PC
- ✓ Finish with "Save".

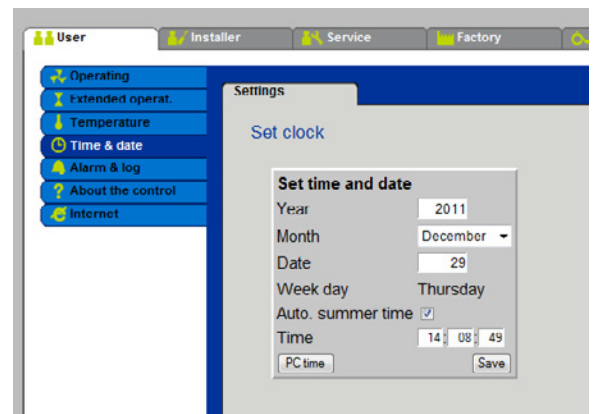

User settings

Setting user functions

Alarm & log

Alarms

- ✓ Shows a list of current alarms in the system
- ✓ Alarm number is shown
- ✓ Alarm text is shown
- ✓ Red text indicates A-alarms
- ✓ Blue text indicates B-alarms
- ✓ Click "Reset alarms" to acknowledge alarms
- ✓ When "Reset alarms" is activated, the alarm list is deleted and active alarms are restored and displayed on the new alarm list.



Alarm log

- ✓ Shows a list of the last 16 alarms recorded by the system
- ✓ Alarm number is shown
- ✓ Alarm text is shown
- ✓ Click "Reset alarms" to acknowledge alarms

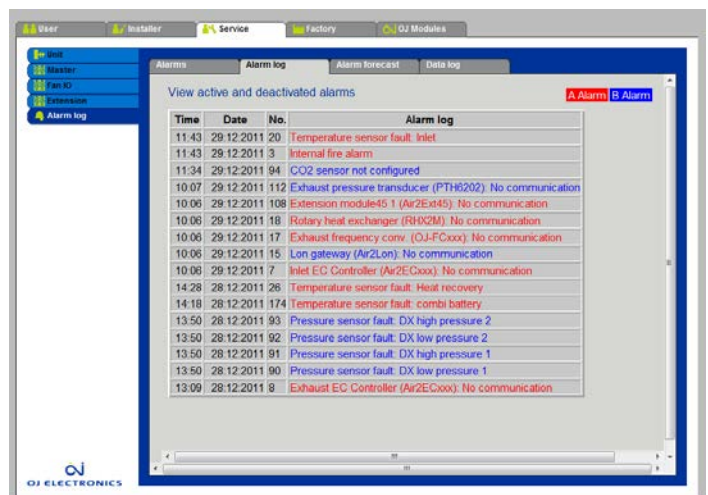

Alarm forecast

- ✓ Shows a list of alarms which have been detected by the system but have not yet been activated because of a time delay.
- ✓ For example, a filter alarm with a time delay of 20 minutes will be shown on this list when the pressure drop across the filter exceeds the alarm level set.
- ✓ If the pressure drop still exceeds the limit set after the 20 minutes have elapsed, the alarm will be activated, deleted from the "Alarm forecast" list and added to the "Alarms" list.



A list of A-alarms, B-alarms, alarm limits and alarm delays can be seen in section 11 of this folder.

User settings

Setting user functions

Data log

System values are saved in a data log in the OJ-Air2 Master for one week, allowing values to be viewed for the previous week or previous 24-hour period.

Tick the required parameter to select what is to be shown in the various groups:

- ✓ Inlet (m3/h) or (Pa) with pressure control
- ✓ Extract (m3/h) or (Pa) with pressure control
- ✓ Temperature (°C)
- ✓ Flow (m3/h)
- ✓ Active alarms (number)
- ✓ Heating/Heat recovery/Cooling (%)

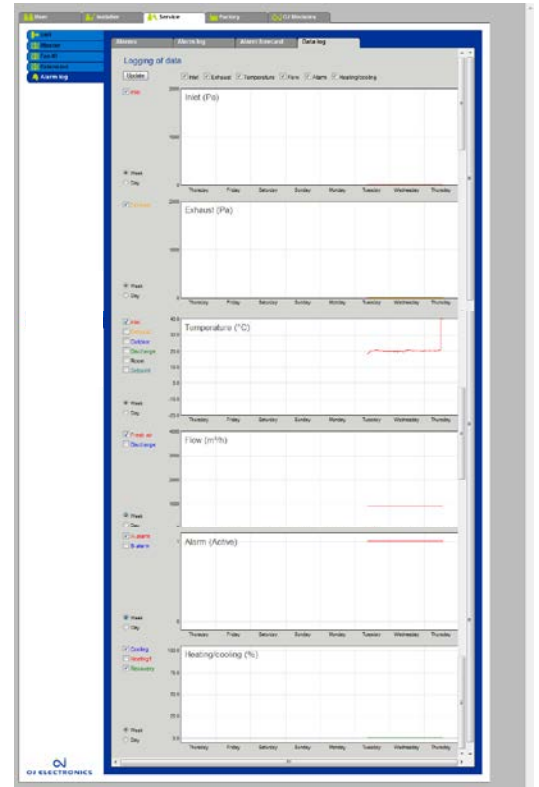

Within each group, select the values to be shown

Display data for previous week

Display data for previous day

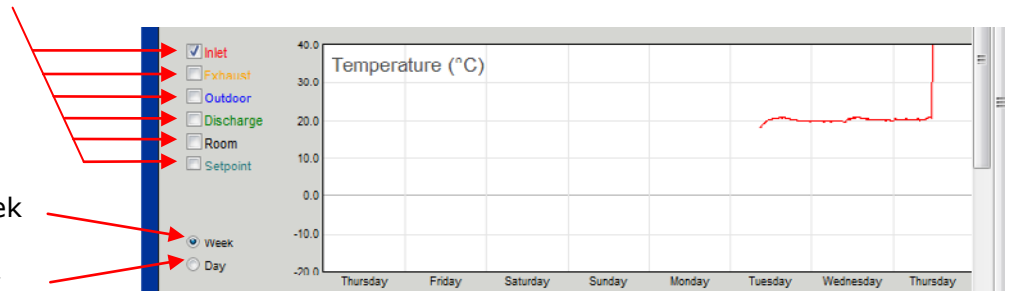

Click the display with the left-hand mouse button to enlarge the diagram.

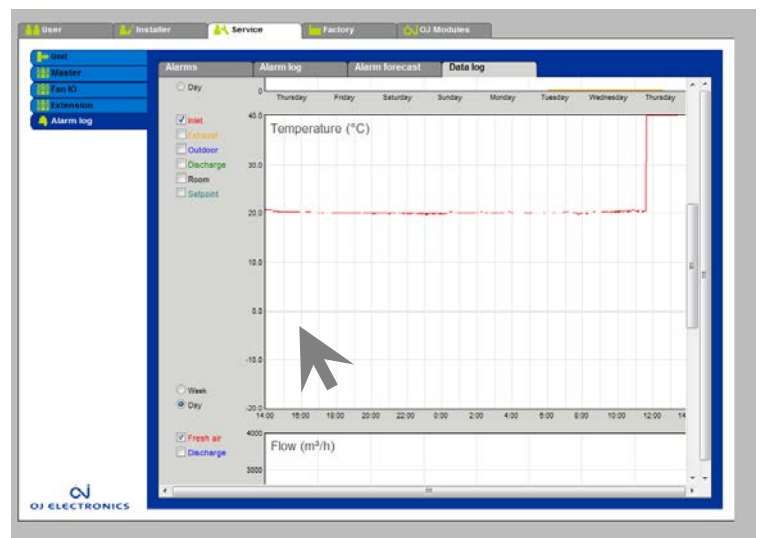

User settings

Setting user functions

Status display

The display shows an overview of the system's actual status and operating conditions.

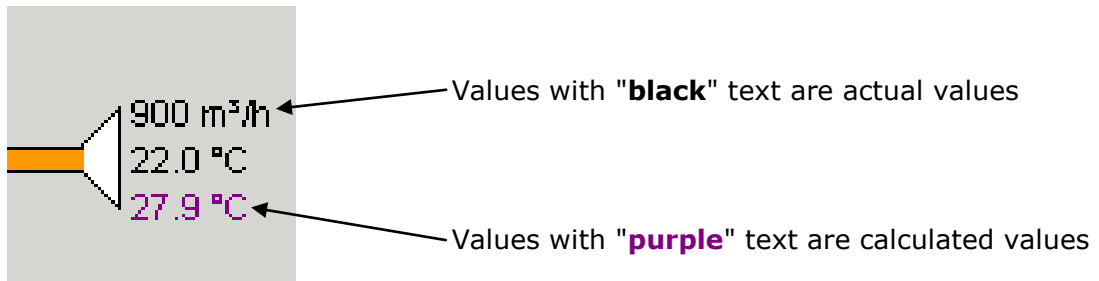
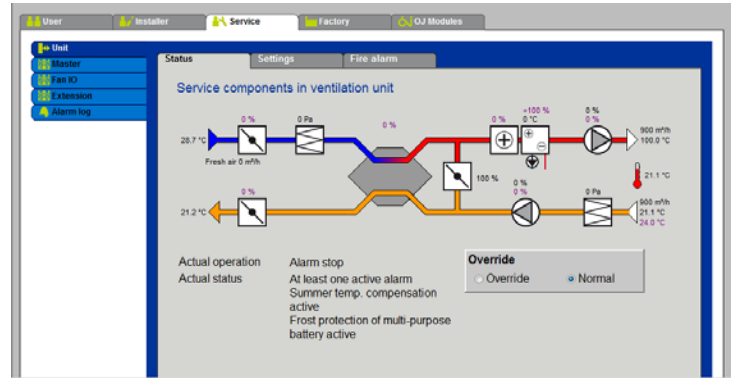

Actual operating conditions and status are described in simple text:

Actual operation	Alarm stop
Actual status	At least one active alarm
	Summer temp. compensation active
	Frost protection of multi-purpose battery active

Installer settings

Setting control functions

Under the "Installer->Operating->Setpoint" tab, you can set the way in which fans and air volumes are to be controlled and regulated.

Fans and air volumes can be controlled according to the following operating modes:

General information on startup sequence

When the system is activated, the following startup sequence is followed regardless of the selected control type (constant pressure, constant flow, CO₂, exhaust slave, etc.):

1. The exhaust fan is started.
 - 1.1. Heat recovery is overridden to 100% (rotary, cross-flow, counter-flow or fluid coupled heat exchanger).
 - 1.2. The heating valve is overridden to the value (Startup heating) set under "Factory/Settings/Components" – only applies in the case of a water-based heating battery.
2. Exhaust fan speed is increased until it reaches the setpoint for air quantity/duct pressure.
3. When the exhaust fan has reached its setpoint, the inlet fan is started.
4. Inlet fan speed is increased until it reaches 50% of the setpoint for air quantity/duct pressure.
5. When the inlet fan has passed 50% of the setpoint for air quantity/duct pressure, the override signals for heat recovery and heating valve (see items 1.1 and 1.2 above) are discontinued.

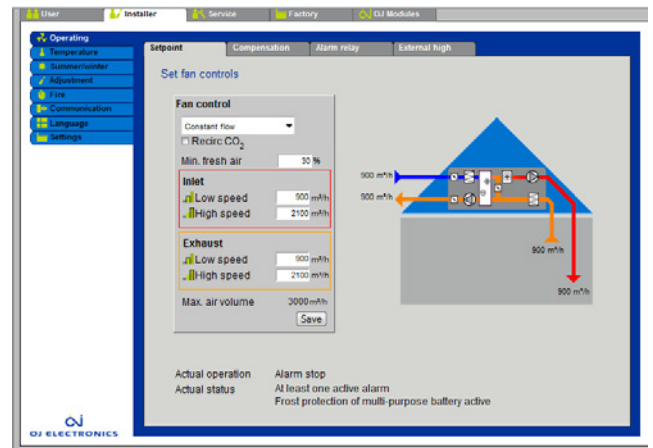

Constant pressure

- ✓ Inlet and extract fans are controlled in relation to the pressure in the inlet and extract ducts respectively.
- ✓ The system must be equipped with two separate pressure transmitters, one in the inlet duct and the other in the extract duct.
- ✓ Pressure transmitters of PTH type are suitable.
- ✓ Pressure transmitters used to measure pressure differences across the fans cannot be omitted as these are used to regulate the air flow.

Constant flow

- ✓ Inlet and extract fans are controlled in relation to flow/air volumes in the inlet and extract ducts respectively.
- ✓ Air volumes are measured/calculated by measuring the difference between static and dynamic pressure across the fan.
- ✓ The difference between static and dynamic pressure is measured by means of pressure transmitters, either the pressure transmitters built into the OJ-Air2 FanIO or pressure transmitters of PTH type.

Extract slave

- ✓ The inlet fan is controlled in relation to the pressure in the inlet duct while the extract fan is controlled as a slave of the inlet fan with a freely selected offset.
- ✓ The system need only be equipped with pressure transmitters in the inlet duct.
- ✓ Pressure transmitters of PTH type are suitable.
- ✓ Pressure transmitters used to measure pressure differences across the fans cannot be omitted as these are used to regulate the air flow.

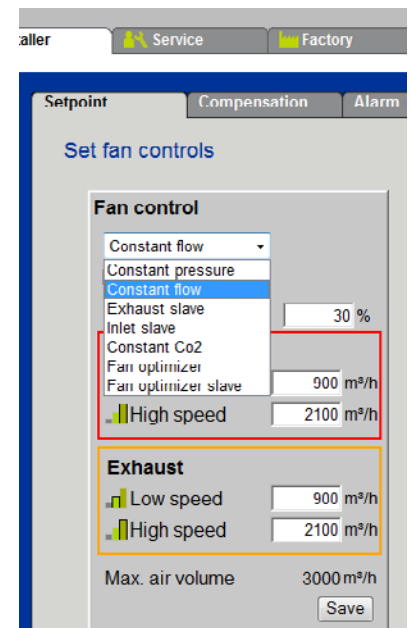

Inlet slave

- √ The extract fan is controlled in relation to the pressure in the extract duct while the inlet fan is controlled as a slave of the extract fan with a freely selected offset.
- √ The system need only be equipped with pressure transmitters in the extract duct.
- √ Pressure transmitters of PTH type are suitable.
- √ Pressure transmitters used to measure pressure differences across the fans cannot be omitted as these are used to regulate the air flow.

Constant CO2

- √ The system must be configured with a CO2 sensor.
- √ The CO2 sensor can either be positioned in the room as a room sensor or in the extract duct as a duct sensor.
- √ Irrespective of whether the CO2 sensor is a room or duct sensor, the CO2 sensor must be configured under "OJ Modules>Configure>Analogue I/O".

CO2 control with modulated recirculation

- √ If the system is configured for "Recirculation", the CO2 concentration in the room is controlled by regulating the recirculation damper.
 - If the CO2 concentration in the room rises, the recirculation damper is regulated in a modulated fashion (0-10V=0-100%) towards closed position while the fresh-air intake damper is regulated towards 100% open.
 - If the CO2 level in the room falls, the recirculation damper is regulated in a modulated fashion (0-10V=0-100%) towards open position while the fresh-air intake damper is regulated towards closed – on the condition that the "Minimum fresh air" setting has not been reached.

CO2 control without modulated recirculation

- √ If the system is not configured for "Recirculation", the CO2 concentration in the room is controlled by regulating air volume via fan speed.
 - If the CO2 level in the room rises, fan speed is increased, thus increasing air volume/air turnover towards the max. air volume setting.
 - If the CO2 level in the room falls, fan speed is decreased, thus reducing air volume/air turnover towards the min. air volume setting.

Fan optimizer

- √ Inlet and extract fans are controlled by a signal from a Belimo fan optimizer in the inlet and extract ducts respectively.
- √ The Belimo fan optimizer signal (0-10V) should be connected as analogue input as described in Section 3: "Electrical configuration" > Configure > Analogue I/O".
- √ The system must be equipped with two separate Belimo fan optimizers, one in the inlet duct and the other in the extract duct.
- √ Pressure transmitters used to measure pressure differences across the fans cannot be omitted as these are used to regulate the air flow.

Fan optimizer slave

- √ The inlet fan is controlled by a signal from a Belimo fan optimizer in the inlet duct while the extract fan is controlled as a slave of the inlet fan with a freely selected offset.
- √ The Belimo fan optimizer signal (0-10V) should be connected as analogue input as described in Section 3: "Electrical configuration" > Configure > Analogue I/O".
- √ The system need only be equipped with one Belimo fan optimizer in the inlet duct.
- √ Pressure transmitters used to measure pressure differences across the fans cannot be omitted as these are used to regulate the air flow.

Installer settings

Setting control functions

Fan control: Constant pressure - *without modulated recirculation*

In order for the pressure range to be set correctly, the pressure transmitter actually installed must first be set correctly.

Click the "Transducer" button for inlet and extract respectively and set the pressure transmitter's maximum range (in Pa), which also corresponds to the maximum output signal from the pressure transmitter (10V).

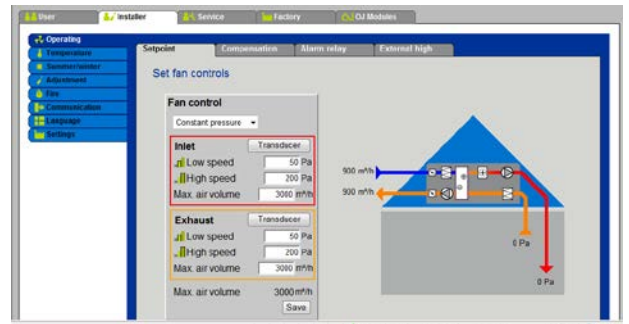

Inlet

Low speed

- ✓ Set the required setpoint for inlet duct pressure at "Low" speed.

High speed

- ✓ Set the required setpoint for inlet duct pressure at "High" speed.

Max. air volume

- ✓ Set the required setpoint for maximum air volume in the inlet duct. Air volume has higher priority than the pressure setpoint, i.e. if the pressure setpoint is not achieved before the maximum air volume is reached, the air volume setting will prevent further increases in fan speed.

Min. air volume

- ✓ Minimum air volume is pre-set in the controls to 15% of maximum air volume. Minimum air volume has higher priority than pressure control.

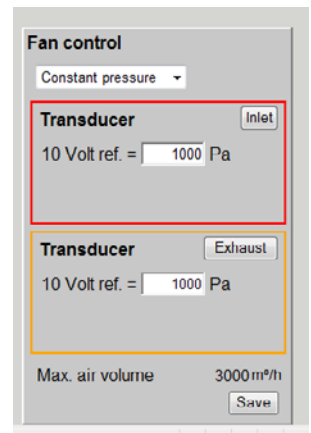

Extract

Low speed

- ✓ Set the required setpoint for extract duct pressure at "Low" speed.

High speed

- ✓ Set the required setpoint for extract duct pressure at "High" speed.

Max. air volume

- ✓ Set the required setpoint for maximum air volume in the extract duct.
- ✓ Air volume has higher priority than the pressure setpoint, i.e. if the pressure setpoint is not achieved before the maximum air volume is reached, the air volume setting will prevent further increases in fan speed.

Min. air volume

- ✓ Minimum air volume is pre-set in the controls to 15% of maximum air volume. Minimum air volume has higher priority than pressure control.

Installer settings

Setting control functions

Fan control: Constant pressure

- *with modulated recirculation*

If "Recirculation" is selected under "OJ Modules > Configure > Settings", you can here choose to control recirculation in relation to the chosen CO2 setpoint.

In order for the pressure range to be set correctly, the pressure transmitter actually installed must first be set correctly.

Click the "Transducer" button for inlet and extract respectively and set the pressure transmitter's maximum range (in Pa), which also corresponds to the maximum output signal from the pressure transmitter (10V).

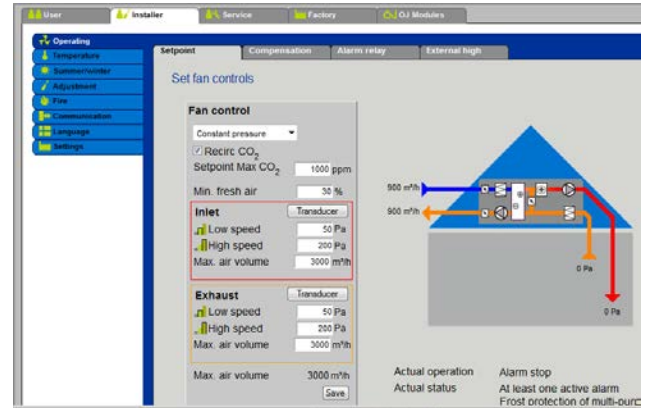

Recirculation CO2

Set the required setpoint for CO2 concentration in ppm.

Minimum fresh air

Set the required setpoint for minimum fresh-air intake for recirculation.

Inlet

Low speed

- ✓ Set the required setpoint for inlet duct pressure at "Low" speed.

High speed

- ✓ Set the required setpoint for inlet duct pressure at "High" speed.

Max. air volume

- ✓ Set the required setpoint for maximum air volume in the inlet duct.

Air volume has higher priority than the pressure setpoint, i.e. if the pressure setpoint is not achieved before the maximum air volume is reached, the air volume setting will prevent further increases in fan speed.

Min. air volume

- ✓ Minimum air volume is pre-set in the controls to 15% of maximum air volume. Minimum air volume has higher priority than pressure control.

Extract

Low speed

- ✓ Set the required setpoint for extract duct pressure at "Low" speed.

High speed

- ✓ Set the required setpoint for extract duct pressure at "High" speed.

Max. air volume

- ✓ Set the required setpoint for maximum air volume in the extract duct.
- ✓ Air volume has higher priority than the pressure setpoint, i.e. if the pressure setpoint is not achieved before the maximum air volume is reached, the air volume setting will prevent further increases in fan speed.

Min. air volume

- ✓ Minimum air volume is pre-set in the controls to 15% of maximum air volume. Minimum air volume has higher priority than pressure control.

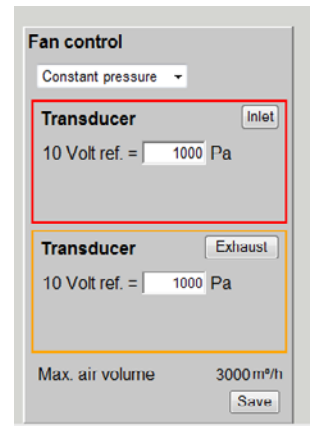

Installer settings

Fan control: Constant flow

- *without modulated recirculation*

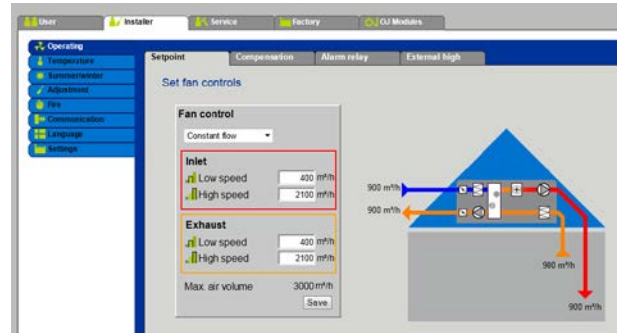

Inlet

Low speed

- √ Set the required setpoint for inlet flow at "Low" speed.

High speed

- √ Set the required setpoint for inlet flow at "High" speed.

Max. air volume

- √ Max. inlet air volume for the unit is set under "Factory".

Min. air volume

- √ Minimum air volume is pre-set in the controls to 15% of maximum air volume.
- √ Setpoints for "Low" and "High" cannot therefore be set to values lower than 15% of maximum air volume.

Extract

Low speed

- √ Set the required setpoint for extract flow at "Low" speed

High speed

- √ Set the required setpoint for extract flow at "High" speed

Max. air volume

- √ Max. extract air volume for the unit is set under "Factory".

Min. air volume

- √ Minimum air volume is pre-set in the controls to 15% of maximum air volume.
- √ Setpoints for "Low" and "High" cannot therefore be set to values lower than 15% of maximum air volume.

Installer settings

Fan control: Constant flow

- *with modulated recirculation*

If "Recirculation" has been selected under "OJ Modules > Configure > Settings" and a recirculation damper has been configured under "Factory > Configuration > Mechanical", you can here choose to control recirculation in relation to the chosen CO2 setpoint.

Recirculation CO2

Set the required setpoint for CO2 concentration in ppm.

Minimum fresh air

Set the required setpoint for minimum fresh air intake for modulated recirculation.

Inlet

Low speed

- √ Set the required setpoint for inlet flow at "Low" speed.

High speed

- √ Set the required setpoint for inlet flow at "High" speed.

Max. air volume

- √ Max. inlet air volume for the unit is set under "Factory".

Min. air volume

- √ Minimum air volume is pre-set in the controls to 15% of maximum air volume.
- √ Setpoints for "Low" and "High" cannot therefore be set to values lower than 15% of maximum air volume.

Extract

Low speed

- √ Set the required setpoint for extract flow at "Low" speed

High speed

- √ Set the required setpoint for extract flow at "High" speed

Max. air volume

- √ Max. extract air volume for the unit is set under "Factory".

Min. air volume

- √ Minimum air volume is pre-set in the controls to 15% of maximum air volume.
- √ Setpoints for "Low" and "High" cannot therefore be set to values lower than 15% of maximum air volume.

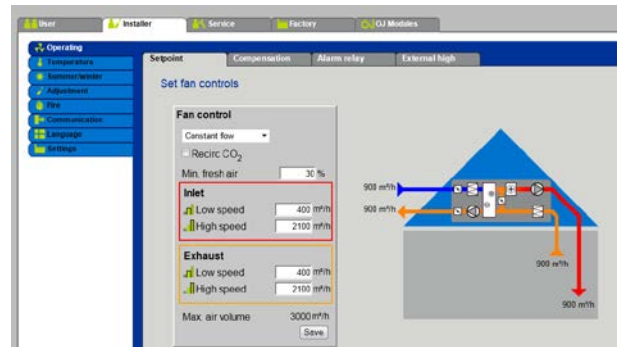

Installer settings

Fan control: Extract slave

- **without** modulated recirculation

Pressure transmitter adjustment

In order for the pressure range to be set correctly, the pressure transmitter actually installed must first be set correctly.

Click the "Transducer" button for inlet and extract respectively and set the pressure transmitter's maximum range (in Pa), which also corresponds to the maximum output signal from the pressure transmitter (10V).

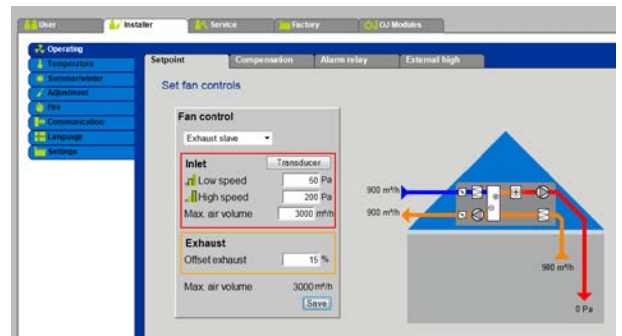

Inlet

Low speed

- √ Set the required setpoint for inlet duct pressure at "Low" speed.

High speed

- √ Set the required setpoint for inlet duct pressure at "High" speed.

Max. air volume

- √ Set the required setpoint for maximum air volume in the inlet duct.
- √ Air volume has higher priority than the pressure setpoint, i.e. if the pressure setpoint is not achieved before the maximum air volume is reached, the air volume setting will prevent further increases in fan speed.
- √ Max. air volume cannot be set to values higher than max. unit air volume, which is set under "Factory".

Min. air volume

- √ Minimum air volume is pre-set in the controls to 15% of maximum air volume. Minimum air volume has higher priority than pressure control.

Extract

Offset extract

- √ Extract air volume follows inlet air volume with an offset corresponding to the value set.

Installer settings

Fan control: Extract slave

- *with modulated recirculation*

Pressure transmitter adjustment

In order for the pressure range to be set correctly, the pressure transmitter actually installed must first be set correctly.

Click the "Transducer" button for inlet and extract respectively and set the pressure transmitter's maximum range (in Pa), which also corresponds to the maximum output signal from the pressure transmitter (10V).

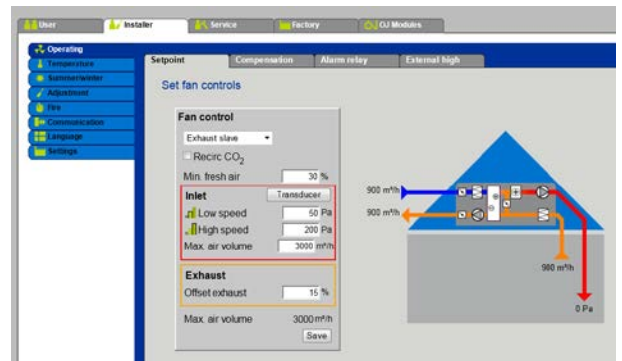

If "Recirculation" has been selected under "OJ Modules > Configure > Settings" and a recirculation damper has been configured under "Factory > Configuration > Mechanical", you can here choose to control recirculation in relation to the chosen CO2 setpoint.

Recirculation CO2

Set the required setpoint for CO2 concentration in ppm.

Minimum fresh air

Set the required setpoint for minimum fresh-air intake for recirculation.

Inlet

Low speed

- √ Set the required setpoint for inlet duct pressure at "Low" speed.

High speed

- √ Set the required setpoint for inlet duct pressure at "High" speed.

Max. air volume

- √ Set the required setpoint for maximum air volume in the inlet duct.
- √ Air volume has higher priority than the pressure setpoint, i.e. if the pressure setpoint is not achieved before the maximum air volume is reached, the air volume setting will prevent further increases in fan speed.
- √ Max. air volume cannot be set to values higher than max. unit air volume, which is set under "Factory".

Min. air volume

- √ Minimum air volume is pre-set in the controls to 15% of maximum air volume. Minimum air volume has higher priority than pressure control.

Extract

Offset extract

- √ Extract air volume follows inlet air volume with an offset corresponding to the value set.

Installer settings

Fan control: Inlet slave

- **without** modulated recirculation

Pressure transmitter adjustment

In order for the pressure range to be set correctly, the pressure transmitter actually installed must first be set correctly.

Click the "Transducer" button for inlet and extract respectively and set the pressure transmitter's maximum range (in Pa), which also corresponds to the maximum output signal from the pressure transmitter (10V).

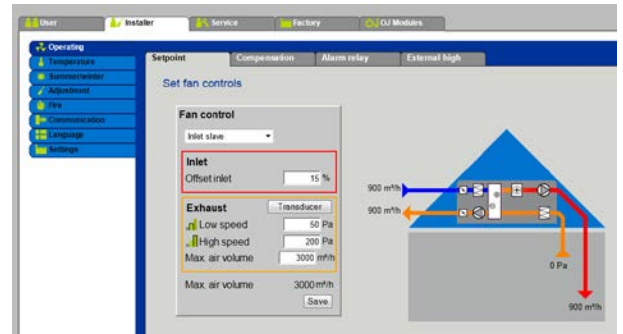

Extract

Low speed

- √ Set the required setpoint for extract duct pressure at "Low" speed.

High speed

- √ Set the required setpoint for extract duct pressure at "High" speed.

Max. air volume

- √ Set the required setpoint for maximum air volume in the extract duct.
- √ Air volume has higher priority than the pressure setpoint, i.e. if the pressure setpoint is not achieved before the maximum air volume is reached, the air volume setting will prevent further increases in fan speed.
- √ Max. air volume cannot be set to values higher than max. unit air volume, which is set under "Factory".

Min. air volume

- √ Minimum air volume is pre-set in the controls to 15% of maximum air volume. Minimum air volume has higher priority than pressure control.

Extract

Offset inlet

- √ Inlet air volume follows extract air volume with an offset corresponding to the value set.

Installer settings

Fan control: Inlet slave

- **with** modulated recirculation

Pressure transmitter adjustment

In order for the pressure range to be set correctly, the pressure transmitter actually installed must first be set correctly.

Click the "Transducer" button for extract and set the pressure transmitter's maximum range (in Pa), which also corresponds to the maximum output signal from the pressure transmitter (10V).

If "Recirculation" has been selected under "OJ Modules > Configure > Settings" and a recirculation damper has been configured under "Factory > Configuration > Mechanical", you can here choose to control recirculation in relation to the chosen CO2 setpoint.

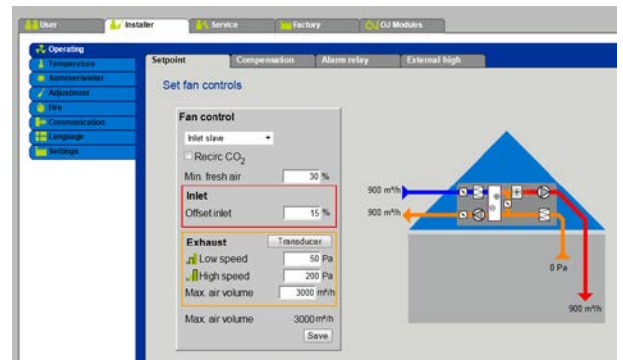

Recirculation CO2

Set the required setpoint for CO2 concentration in ppm.

Minimum fresh air

Set the required setpoint for minimum fresh-air intake for recirculation.

Extract

Low speed

- √ Set the required setpoint for extract duct pressure at "Low" speed.

High speed

- √ Set the required setpoint for extract duct pressure at "High" speed.

Max. air volume

- √ Set the required setpoint for maximum air volume in the extract duct.
- √ Air volume has higher priority than the pressure setpoint, i.e. if the pressure setpoint is not achieved before the maximum air volume is reached, the air volume setting will prevent further increases in fan speed.
- √ Max. air volume cannot be set to values higher than max. unit air volume, which is set under "Factory".

Min. air volume

- √ Minimum air volume is pre-set in the controls to 15% of maximum air volume. Minimum air volume has higher priority than pressure control.

Inlet

Offset inlet

- √ Inlet air volume follows extract air volume with an offset corresponding to the value set.

Installer settings

Fan control: Constant CO2

- **without** modulated recirculation

- ✓ The function is used to maintain a constant/maximum CO2 level in a room or extract duct.
- ✓ If the CO2 level is higher than the setpoint, extract volume will be increased in a modulated fashion to max. air volume.
- ✓ If the CO2 level is lower than the setpoint, extract volume will be decreased in a modulated fashion to min. air volume.
- ✓ Inlet air volume follows extract air volume with an offset corresponding to the set value.

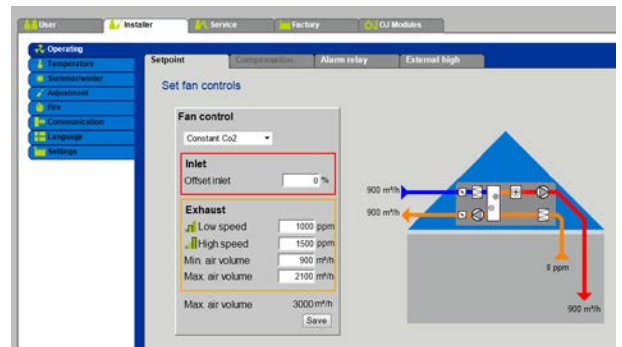

Inlet

- ✓ Set the required offset for inlet air volume.

Extract

Low speed

- ✓ Set the required setpoint for extract duct pressure at "Low" speed.

High speed

- ✓ Set the required setpoint for extract duct pressure at "High" speed.

Min. air volume

- ✓ Minimum air volume cannot be set to a value lower than 15% of maximum air volume.

Max. air volume

- ✓ Set the required setpoint for maximum air volume in the extract duct.
- ✓ Max. air volume cannot be set to values higher than max. unit air volume, which is set under "Factory".

Installer settings

Fan control: Constant CO2

- **with** modulated recirculation

- ✓ The function is used to maintain a constant/maximum CO2 level in a room or extract duct.

Increased ventilation demand – high CO2 level:

- ✓ If the CO2 level is higher than the setpoint, ventilation will be increased in a modulated fashion according to the following sequence:
 1. Extract air volume is increased in a modulated fashion to max. air volume.
 2. Fresh-air volume is increased in a modulated fashion to 100% fresh air.

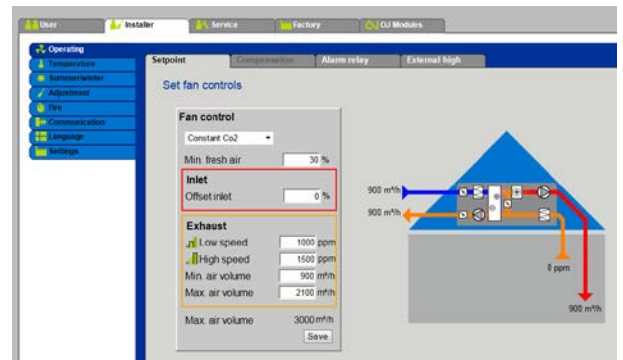

Reduced ventilation demand – low CO2 level:

- ✓ If the CO2 level is lower than the setpoint, ventilation will be decreased in a modulated fashion according to the following sequence:
 1. Fresh-air volume is reduced to the minimum fresh air setting.
 2. Extract air volume is reduced in a modulated fashion to min. air volume.
- ✓ Inlet air volume follows extract air volume with an offset corresponding to the set value.

Inlet

- ✓ Set the required offset for inlet air volume.

Extract

Low speed

- ✓ Set the required setpoint for extract duct pressure at "Low" speed.

High speed

- ✓ Set the required setpoint for extract duct pressure at "High" speed.

Min. air volume

- ✓ Minimum air volume cannot be set to a value lower than 15% of maximum air volume.

Max. air volume

- ✓ Set the required setpoint for maximum air volume in the extract duct.
- ✓ Max. air volume cannot be set to values higher than max. unit air volume, which is set under "Factory".

Installer settings

Fan control: Fan optimizer

- **without** modulated recirculation

- ✓ Inlet and extract volumes are controlled separately by a Belimo fan optimizer.
- ✓ It is solely the 0-10V signal from the Belimo fan optimizer that determines the speed of the fans.

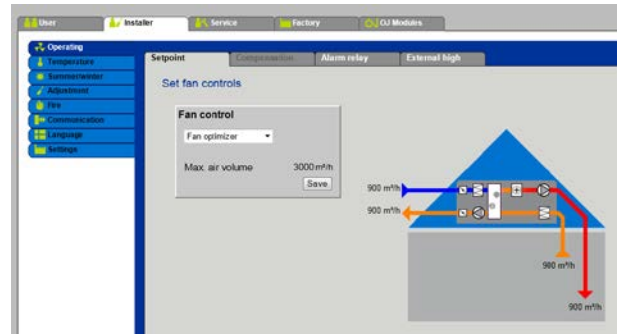

Fan control: Fan optimizer

- **with** modulated recirculation

- ✓ Inlet and extract volumes are controlled separately by a Belimo fan optimizer.
- ✓ It is solely the 0-10V signal from the Belimo fan optimizer that determines the speed of the fans.

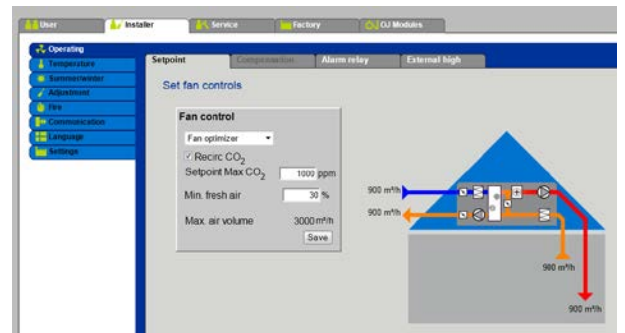

If "Recirculation" has been selected under "OJ Modules > Configure > Settings" and a recirculation damper has been configured under "Factory > Configuration > Mechanical", you can here choose to control recirculation in relation to the chosen CO2 setpoint.

Recirculation CO2

Set the required setpoint for CO2 concentration in ppm.

Minimum fresh air

Set the required setpoint for minimum fresh-air intake for recirculation.

Installer settings

Fan control: Fan optimizer slave

- **without** modulated recirculation

- ✓ Inlet air volume is controlled by a Belimo fan optimizer.
- ✓ It is solely the 0-10V signal from the Belimo fan optimizer that determines the speed of the inlet fan.



Extract

Offset extract

- ✓ Extract air volume follows inlet air volume with an offset corresponding to the value set.

Fan control: Fan optimizer slave

- **with** modulated recirculation

- ✓ Inlet air volume is controlled by a Belimo fan optimizer.
- ✓ It is solely the 0-10V signal from the Belimo fan optimizer that determines the speed of the inlet fan.

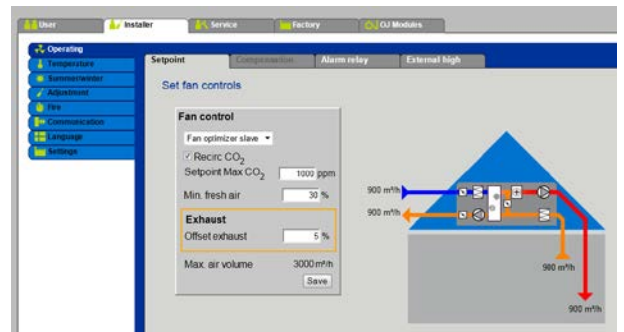

If "Recirculation" has been selected under "OJ Modules > Configure > Settings" and a recirculation damper has been configured under "Factory > Configuration > Mechanical", you can here choose to control recirculation in relation to the chosen CO2 setpoint.

Recirculation CO2

Set the required setpoint for CO2 concentration in ppm.

Minimum fresh air

Set the required setpoint for minimum fresh air intake for recirculation.

Installer settings

Setting control functions

Fan control: Green Zone

- **without** modulated recirculation

- ✓ Ventilation flow is controlled individually in inlet and exhaust ducts by an OJ Green Zone Master.
- ✓ It is solely the 0-10V signal from the OJ Green Zone Master that determines the speed of the fans.

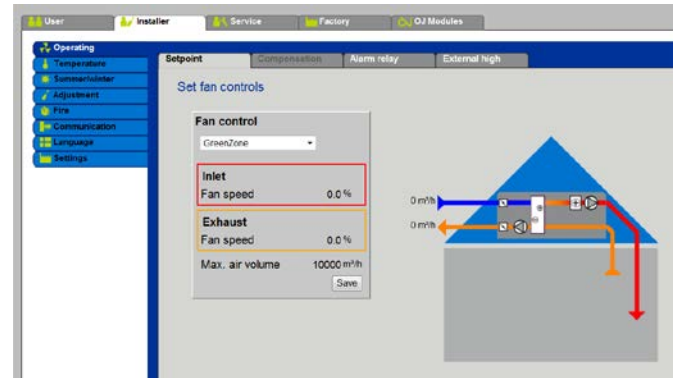

Fan control: Green Zone

- **with** modulated recirculation

- ✓ Ventilation flow is controlled individually in inlet and exhaust ducts by an OJ Green Zone Master.
- ✓ It is solely the 0-10V signal from the OJ Green Zone Master that determines the speed of the fans.

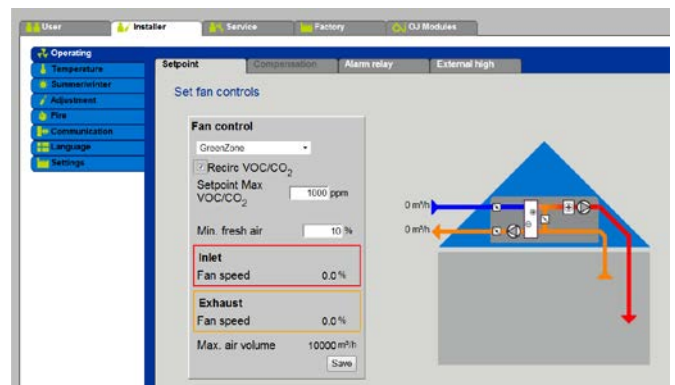

If "Modulated recirculation" has been selected under "OJ Modules > Configure > Settings" and a recirculation damper has been configured under "Factory > Configuration > Mechanical", you can here choose to control recirculation in relation to the chosen VOC/CO2 setpoint.

Recirculation VOC/CO2

Set setpoint for VOC/CO2 concentration in ppm.

Minimum fresh air

Set the required setpoint for minimum fresh-air intake with modulated recirculation.

Installer settings

Setting control functions

Fan control: Green Zone slave

- **without** modulated recirculation

- ✓ Inlet air flow is controlled by an OJ Green Zone Master.
- ✓ It is solely the 0-10V signal from the OJ Green Zone Master that determines the speed of the inlet fan.

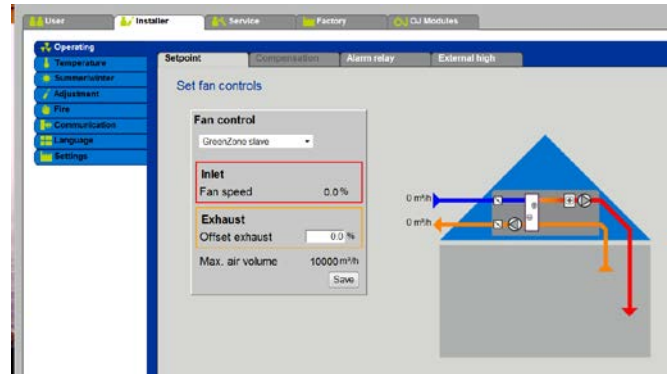

Exhaust

Offset exhaust

- ✓ Exhaust air flow follows inlet air flow with an offset corresponding to the value set.

Fan control: Green Zone slave

- **with** modulated recirculation

- ✓ Inlet air flow is controlled by an OJ Green Zone Master.
- ✓ It is solely the 0-10V signal from the OJ Green Zone Master that determines the speed of the inlet fan.

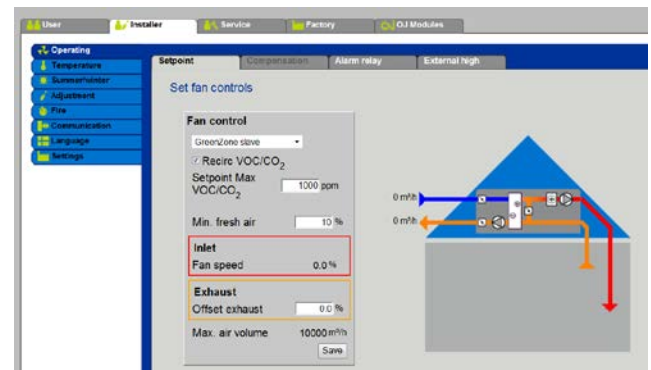

If "Modulated recirculation" has been selected under "OJ Modules > Configure > Settings" and a recirculation damper has been configured under "Factory > Configuration > Mechanical", you can here choose to control recirculation in relation to the chosen VOC/CO2 setpoint.

Recirculation VOC/CO2

Set setpoint for VOC/CO2 concentration in ppm.

Minimum fresh air

Set the required setpoint for minimum fresh-air intake with modulated recirculation.

Installer settings

Setting control functions

Fan control: Constant motor speed % - **without** modulated recirculation

- ✓ The speed of the fans is controlled individually according to the specified setpoints.

Inlet

Low speed

- ✓ Set inlet fan speed to "Low speed".

High speed

- ✓ Set inlet fan speed to "High speed".

Exhaust

Low speed

- ✓ Set exhaust fan speed to "Low speed".

High speed

- ✓ Set exhaust fan speed to "High speed".

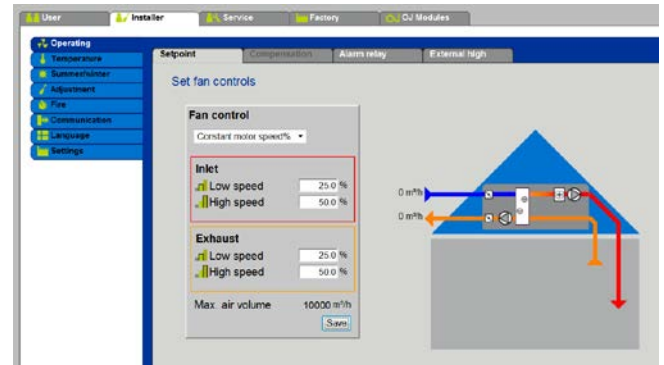

Fan control: Constant motor speed % - **with** modulated recirculation

- ✓ The speed of the fans is controlled individually according to the specified setpoints.

Inlet

Low speed

- ✓ Set inlet fan speed to "Low speed".

High speed

- ✓ Set inlet fan speed to "High speed".

Exhaust

Low speed

- ✓ Set exhaust fan speed to "Low speed".

High speed

- ✓ Set exhaust fan speed to "High speed".

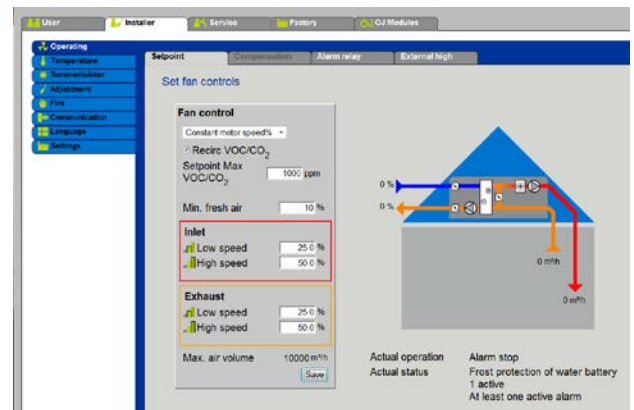

Modulated recirculation

If "Modulated recirculation" has been selected under "OJ Modules > Configure > Settings" and a recirculation damper has been configured under "Factory > Configuration > Mechanical", you can here choose to control recirculation in relation to the chosen VOC/CO2 setpoint.

Recirculation VOC/CO2

Set setpoint for VOC/CO2 concentration in ppm.

Minimum fresh air

Set the required setpoint for minimum fresh-air intake with modulated recirculation.

Installer settings

Setting control functions

Fan control: Compensation

Compensation of ventilation level depending on outside temperature.

When outside temperature drops, fan speed can be reduced according to a set curve.

The setpoint will be offset to the compensated setpoint when the outdoor temperature is within the set compensation curve.

Outdoor temperature is measured either by an outdoor sensor or by a sensor in the fresh-air intake.

The function is available with the following control types:

√ Constant flow	Yes
√ Constant pressure	Yes
√ Inlet slave	Yes
√ Extract slave	Yes
√ Constant CO2	No
√ Fan optimizer	No
√ Fan optimizer slave	No

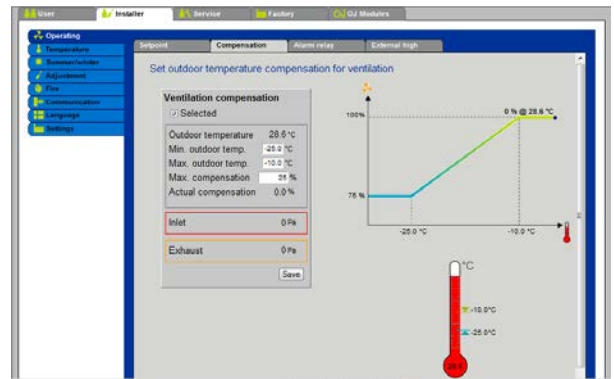

Outdoor temperature

- √ Actual measured outdoor temperature

Min. outdoor temperature

- √ Outdoor temperature for full compensation

Max. outdoor temperature

- √ Outdoor temperature for start of compensation

Max. compensation

- √ Max. setpoint reduction in % at min. outdoor temperature

Actual compensation

- √ Actual compensation in %

Actual level for inlet

Actual level for extract

Installer settings

Setting control functions

Alarm relay function

The system can be configured with two digital outputs, which can be configured to follow A-alarms and/or B-alarms.

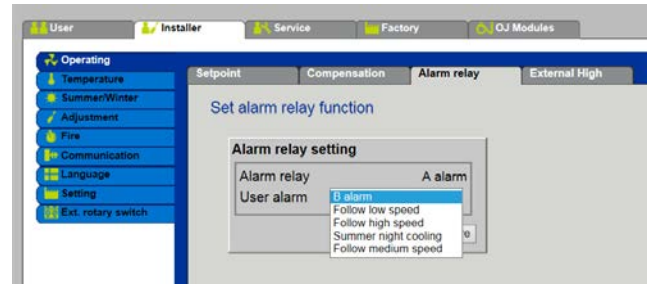

The two digital outputs are configured under "OJ Modules > Configure > Digital I/O".

Select function of "B-alarm" relay:

B-alarm

- ✓ The digital output which is configured for the B-alarm relay, follows B-alarms.

Follow low speed

- ✓ The digital output which is configured for the B-alarm relay, follows low speed.
- ✓ The A-alarm relay is activated by both A-alarms and B-alarms.

Follow high speed

- ✓ The digital output which is configured for the B-alarm relay, follows high speed.
- ✓ The A-alarm relay is activated by both A-alarms and B-alarms.

Follow summer night cooling

- ✓ The digital output like configured to the B-alarm relay, will follow the summer night cooling status.

Follow medium speed

- ✓ The digital output like configured to the B-alarm relay, will follow the medium speed status.

Setting control functions

Installer settings

External high

The "External high" function starts the system or switches the system to the high speed setpoint when the digital input configured for the function under "OJ Modules > Configure > Digital I/O > High speed" is activated.

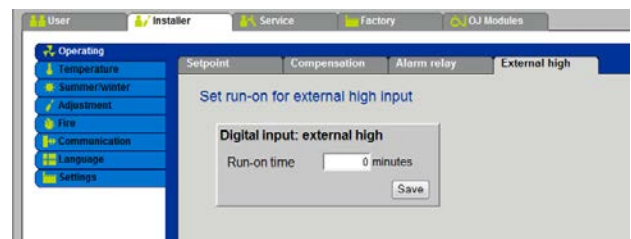

If the system is stopped, "1" on the digital input will start the system at high speed for the set time.

If the system is operating at low speed, it will switch to high speed for the set time.

If the system is already operating at high speed in accordance with the set operating times, it will remain on high speed for the set time.

A-alarms always have higher priority.

Installer settings

Setting control functions

Temperature control

Under the "Installer->Temperature->Control" tab, you can set the way in which temperature is to be controlled and regulated.

The temperature controller can be set to operate in one of the following modes:

Constant inlet

- √ Temperature is controlled in relation to constant inlet temperature measured by the inlet sensor located in the inlet duct.
- √ The required inlet temperature setpoint is set under: "User > Temperature"
- √ Room sensor: Sensor correction/sensor-offset (*settings area* = +/-3°C)
- √ "External setpoint" allows the chosen inlet temperature setpoint to be offset by +/-5°C from a setpoint adjuster (OJ-Air2 WP55) located externally, e.g. in the room. Only displayed when the analog input "Temp. setpoint offset" are configured under: **"OJ Modules>Configures>Analog in/out"**.
- √ "External offset" displays the offset for the chosen setpoint.
- √ "Effective setpoint" displays the new, calculated setpoint used by the controls.
- √ Actual values are shown on the graphic.

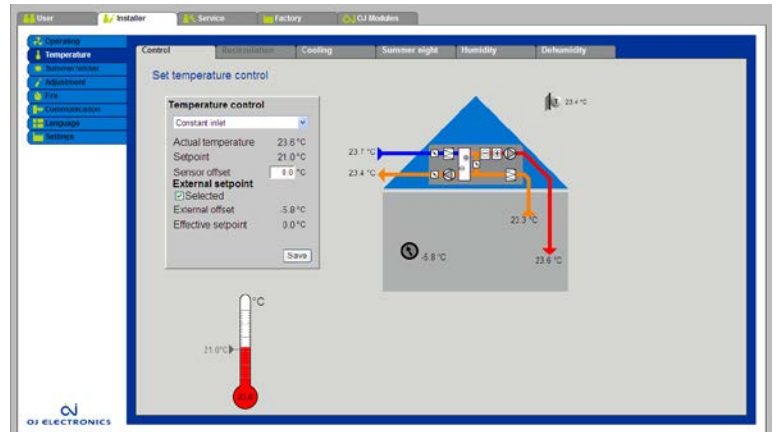

Constant extract

- √ Temperature is controlled in relation to constant extract temperature measured by the extract sensor located in the extract duct.
- √ The required extract temperature setpoint is set under: "User > Temperature"
- √ Roomsensor: Sensor correction/sensor-offset (*settings area* = +/-3°C)
- √ "External setpoint" allows the chosen extract temperature setpoint to be offset by +/-5°C from a setpoint adjuster (OJ-Air2 WP55) located externally, e.g. in the room. Only displayed when the analog input "Temp. setpoint offset" are configured under: **"OJ Modules>Configures>Analog in/out"**.
- √ "External offset" displays the offset for the chosen setpoint.
- √ "Effective setpoint" displays the new, calculated setpoint used by the controls.
- √ Actual values are shown on the graphic.

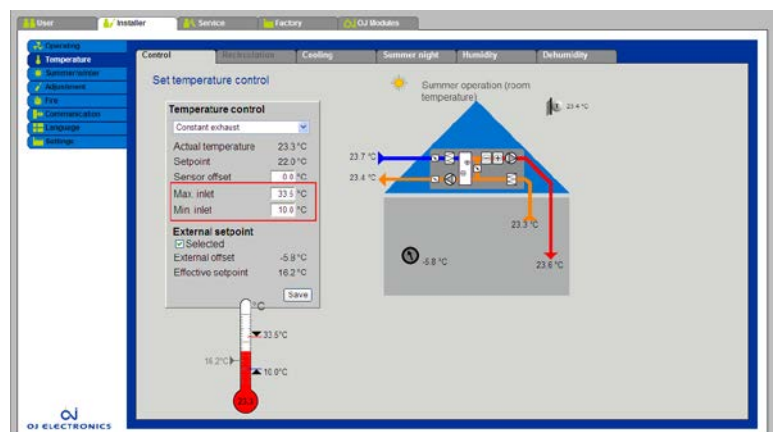

Installer settings

Setting control functions

Temperature control

Constant room

- ✓ Temperature is controlled in relation to constant room temperature measured by the room sensor located in the room.
- ✓ The required room temperature setpoint is set under: "User > Temperature"
- ✓ Room sensor: Sensor correction/sensor-offset (*settings area* = +/-3°C)
- ✓ "External setpoint" allows the chosen extract temperature setpoint to be offset by +/-5°C from a setpoint adjuster (OJ-Air2 WP55) located externally, e.g. in the room. Only displayed when the analog input "Temp. setpoint offset" are configured under: **"OJ Modules>Configures>Analog in/out"**.
- ✓ "External offset" displays the offset for the chosen setpoint.
- ✓ "Effective setpoint" displays the new, calculated setpoint used by the controls.
- ✓ Actual values are shown on the graphic.

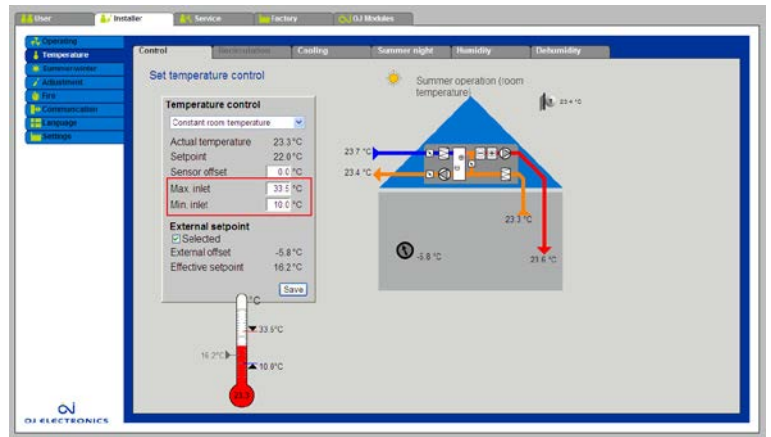

Constant inlet/extract differential

- ✓ Temperature is controlled in relation to the difference between inlet and extract temperature.
- ✓ The required setpoint for the difference between inlet and extract temperature is set under: "User > Temperature"
- ✓ Room sensor: Sensor correction/sensor-offset (*settings area* = +/-3°C)
- ✓ The setpoint chosen specifies the amount by which inlet temperature is to be lower than extract temperature.

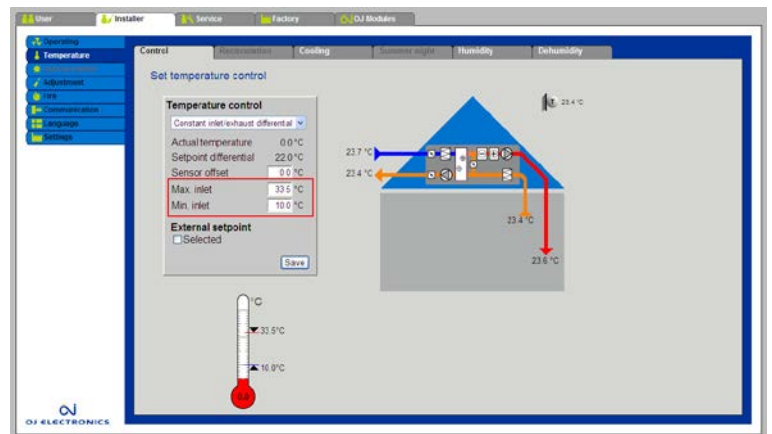

Installer settings

Setting control functions

Recirculation (night-time heating via recirculation)

- *minimum night temperature*

The function is used to ensure that room temperature does not drop below the set value at night when the system is stopped.

The function is only available when a room sensor which measures room temperature and a recirculation damper (on/off) have been configured.

"Normal" must be selected under "OJ Modules > Configure > Settings".

Under the "Installer->Temperature->Recirculation" tab, you can set the way in which temperature is to be controlled and regulated.

Start room temperature

✓ The system starts when room temperature has dropped below the setpoint.

Stop room temperature

✓ The system stops when room temperature has risen above the setpoint.

The system starts with the recirculation damper open, thus recirculating air into the room.

The recirculated air is heated by the heating element.

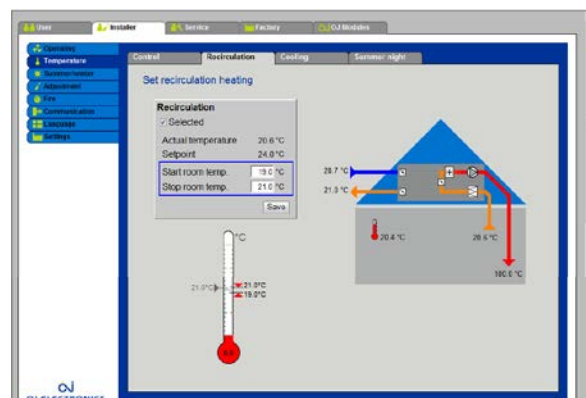

Installer settings

Setting control functions

Cooling

The function is only available if active cooling in the form of a cooling element is installed and configured.

The function is used to ensure that active cooling can be used if certain set preconditions are met.

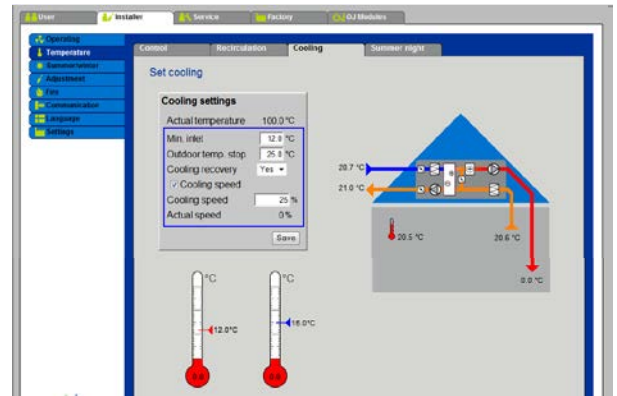

Cooling settings

Min. inlet

- ✓ Setpoint for minimum inlet temperature when cooling is active.

Outdoor temperature stop

- ✓ Cooling is stopped at outdoor temperatures below the setpoint.

Cooling recovery

- ✓ When activated, heat recovery in the form of a cross-flow heat exchanger, rotary heat exchanger or counter-flow heat exchanger will also be activated as cooling recovery.
- ✓ The function will be activated when outdoor temperature is higher than room or extract temperature.

Forced cooling

- ✓ When activated, air volume will be increased when cooling is active.

Speed increase

- ✓ Fan speed is increased with the set percentage when cooling is active.
- ✓ Max. air volume has higher priority.

Enthalpy

Introduction

- ✓ As a general rule, cooling power is generally four times more expensive to generate than heating power. The most cost-effective use of cooling power is therefore to cool the air that is most economical to cool. Enthalpy expresses the energy content of the air and is calculated by measuring the temperature and relative humidity of the air.

Enthalpy control

- ✓ The OJ-Air2 system is equipped with an enthalpy function to provide energy-optimised cooling control.

By positioning combined humidity and temperature sensors in the fresh air and exhaust air ducts, the enthalpy of the two air types can be calculated.

When cooling is demanded, it will always be the air (fresh- or exhaust air) that contains least enthalpy that is cooled. Controlling cooling in relation to the energy content of the air, reduces the energy used for cooling to a minimum.

- If OJ-Air2 is to control cooling in relation to enthalpy, the system must, as a minimum, be configured with a modulating recirculation damper, 2 x HTH humidity sensors (Mixed- and exhaust air) and active cooling.

The function is activated automatically when the minimum requirements given above are met.

Installer settings

Setting control functions

Summer night cooling (free cooling)

The function is used to cool the room with fresh cold air with no use of active cooling, compressor or cold water.

Outdoor sensor (Yes/No)

The summer night cooling function is available with or without an outdoor temperature sensor configured.

- Is an outdoor sensor configured the outdoor sensor is a parameter in the control and the outdoor sensor is used as a start/stop value (see fig. 1) In this case the AHU will check the outdoor temperature all the time between "Start time" and "Stop time" and start up the AHU if the outdoor temperature is higher than the parameter "Outdoor temperature stop". If the outdoor temperature drops to a value lower than the setting in the parameter "Outdoor temperature stop", the AHU will stop.
- Is an outdoor sensor NOT configured, the supply/inlet air sensor is now a parameter in the control.
- The supply air sensor is used as a start/stop value (see fig. 1) In this case the AHU will start up at the scheduled start time to test the temperatures. If the supply air temperature drops to a value lower than the setting in the parameter "Inlet temp. stop" AND the heat exchanger is at 100% - the AHU will stop again.

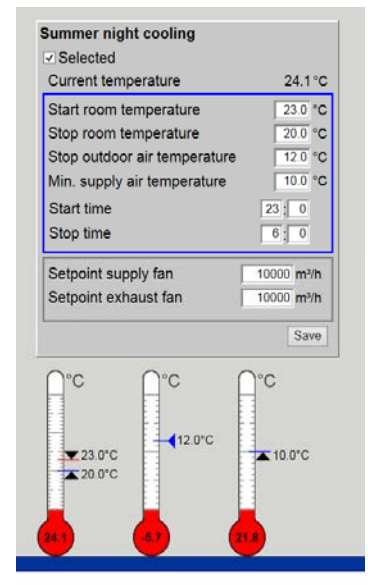

Summer night cooling

Summer night cooling is activated if there was less than 60 minutes heating demand between 12.00 noon and 23.59, during the latest operation period AND all the following conditions are met...!

Start room temperature

- √ Summer night cooling starts at higher room temperature.
- √ If no room sensor is installed, the system will start at the start time set under "Start time" in order to measure the actual room temperature.
- √ Outdoor temperature must be >2°C lower than the measured room/extract temperature

Stop room temperature

- √ Summer night cooling stops at lower room temperature/extract temperature.

Outdoor temperature stop

- √ Summer night cooling stops at lower outdoor temperature.

Min. inlet

- √ Minimum inlet temperature when summer night cooling is active.
- √ Heat exchanger is used to secure minimum inlet temperature

Start time

- √ Earliest time at which summer night cooling starts. **Setting range: Hour 20.00 – 02.00**
- √ If the system is not configured with a room sensor but only with an extract sensor, it will start at the set time in order to check room temperature via the extract sensor.
- √ If the system is configured with a room sensor, it will continually check room temperature and begin operating at the set start time.

Stop time

- √ Time at which summer night cooling stops. **Setting range: Hour 03.00 – 08.00**

Setpoint supply air fan

- √ Give-in the setpoint for supply air fan during summer night cooling.

Setpoint exhaust air fan

- √ Give-in the setpoint for exhaust air fan during summer night cooling.

...to be continued next page...

...continued from previous page...

With or without installed room sensor

Summer night cooling (free cooling) functions irrespective of whether or not a room sensor is installed. If a room sensor (*1) is installed in the room/building, room temperature will, as described above, be measured and monitored by the sensor.

If no room sensor is installed, the exhaust sensor (*1) will be used to measure and monitor the temperature of the room/building.

It is only possible to measure the correct room temperature using the extract air sensor when the unit is running. So if you are using the extract air sensor for measuring the room temperature in the summer night cooling sequence, it is necessary to start the unit shortly to measure the correct room temperature. That's why the controller has a built-in procedure for checking this temperature: See **Start-up for checking/testing**)

Internal or external outdoor temperature sensor

If the outdoor temperature is measured by the internal outdoor temperature sensor, configured on the temperature input "Outdoor air temperature" (*2) the unit will make this check procedure like described under: **Start-up for checking/testing**

If the outdoor temperature sensor is configured and mounted on the temperature input "Outdoor air temperature (external sensor)" (*3), the system will use this sensor as outdoor temperature reference.

As this temperature (*3) sensor measures the outdoor temperature in an ongoing process, the system will not need to make this "**Start-up for checking/testing**"

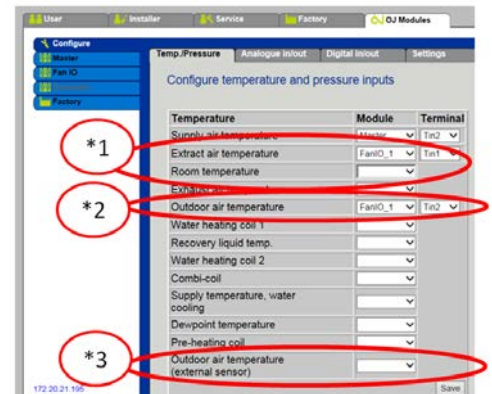

Start-up for checking/testing

As the exhaust sensor is only able to measure room temperature correctly when the exhaust fan is running, the system will start up once during the night. The time at which the system starts is that specified under "Start time". The system then runs for 10 minutes in order to check room temperature and outdoor temperature. If the conditions for summer night cooling are met, the system will remain in operation until the stop conditions are met. Fan speed is fixed to 50% in this operating mode. If the conditions for summer night cooling are not met, the system will stop after 10 minutes of operation. This test start-up is performed only once during a night/stop period at the time specified under "Start time".

Room sensor AND external outdoor sensor

With an external outdoor sensor configured to the temperature input "Outdoor air temperature (external sensor)" and a real room temperature sensor configure to the temperature input "Room temperature", it will not be necessary to make this "**Start-up for checking/testing**". The temperatures will be monitored on an actual updated measurement. If the limits are passed and all conditions are full filled, the unit will start up the summer night cooling process.

Start signal to an external zone control system

The controller do have an digital relay output which can be used for start-up signal to the zone control system for opening the zone dampers during summer night cooling.

This digital output is configured under "Modules > Configure > Digital in- and output"



Setting control functions

Installer settings

Humidification

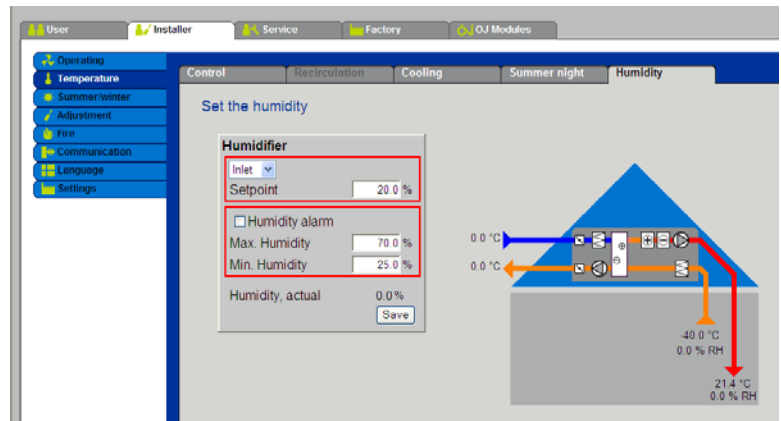

The function is used to humidify the inlet air.

The air humidifier, and thus the humidity in the supply air duct, is controlled and regulated by the humidity sensor located in the supply air duct.

The humidity sensor must be of type HTH-6202 or HTH-6203 from OJ-Electronics.

The humidity sensor can also work as a temperature sensor in the supply air duct.

Humidification

- ✓ None: Humidification is deactivated
- ✓ Inlet: Inlet air humidification is activated
- ✓ Exhaust: Control of extract-/room air is active.
If "Exhaust control" is selected as control type, a humidity sensor must always be installed in both the supply air duct and the extract air duct.

Setpoint

- ✓ Set setpoint for selected control type

Humidity alarm

- ✓ Select whether alarm is to be active

Max. humidity

- ✓ Set setpoint for max. humidity alarm
- ✓ If the system is only configured with a humidity sensor in the supply air duct, the setpoint set for max. humidity alarm applies to the humidity in the supply air duct.
- ✓ If the system is also configured with a humidity sensor in the extract air duct, the setpoint set for max. humidity alarm applies to the humidity in the extract air duct.

Min. humidity

- ✓ Set setpoint for min. humidity alarm
- ✓ If the system is only configured with a humidity sensor in the supply air duct, the setpoint set for min. humidity alarm applies to the humidity in the supply air duct.
- ✓ If the system is also configured with a humidity sensor in the exhaust air duct, the setpoint set for min. humidity alarm applies to the humidity in the extract air duct.

Humidity, actual

- ✓ Actual humidity reading for selected control sensor
- ✓ Supply sensor (*supply setpoint*)
- ✓ Extract sensor (*extract setpoint*)

OBS!

- *Minimum 1 x HTH-620X in the supply air duct*
- *Option is also a HTH-620X in the extract air duct*
- *Air flow measurement on the supply air fan is a must*
- *Analog output "Humidifier" must be configured.*

Installer settings

Setting control functions

Dehumidification

The function is used to lower the relative humidity in the room by dehumidification.

The dehumidification process is intelligently controlled by three moisture sensors (HTH-20X).

When dehumidification of the room is demanded, the energy content of the air (*enthalpy*) is measured continuously in the fresh air and exhaust air respectively. The air that is dehumidified and supplied to the room will thus always be the air that requires least energy for dehumidification.

To obtain optimum control, it is recommended that a dew point sensor is installed and configured between the cooling element and the heating element. This sensor is, however, not absolutely necessary for dehumidification to function. If no dew point sensor is used, dehumidification will be accomplished via a permanently set "% open" value for the cooling element. This value is set under: "Installer > Temperature > Dehumidification" in the menu: "Cooling output"

Dehumidification is accomplished by the installed cooling element while the temperature is maintained according to the setpoint by subsequent heating of the inlet air by the heating element.

Minimum configuration: Three humidity sensors, a recirculation damper and heating and cooling batteries must always be installed to permit dehumidification.

NOTE! A multi-purpose battery cannot replace the heating or cooling battery.

The three humidity sensors should therefore be installed in :

- Inlet duct
- Exhaust duct
- Air mixing point

 = red arrow indicates sensor position

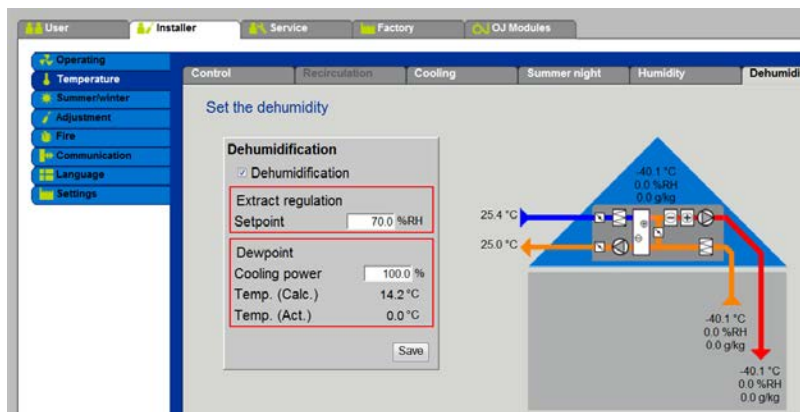
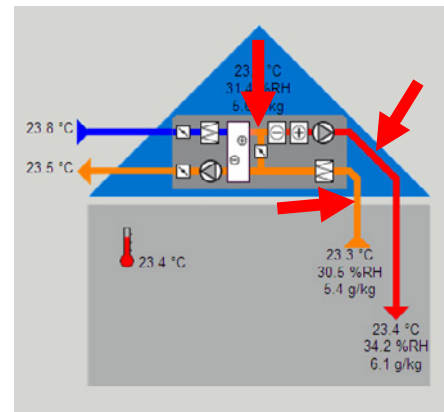

Dehumidification, control

Tick to select whether dehumidification is to be active.

Setpoint

Set setpoint for exhaust control (*exhaust/room air*).

Dew point

Set cooling output for dehumidification if no dew point sensor is installed.

Temp. reading (calculated) = calculated dew point temperature

Temp. reading (actual) = actual dew point temperature

Installer settings

Setting control functions

Summer/winter compensation

Under the tab:
"Installer->Summer/Winter->Compensation", it is possible to set temperature compensation parameters for summer and winter operation.

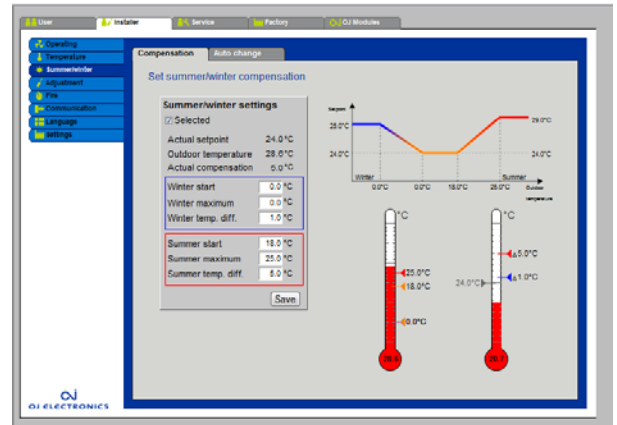

When selected, compensation offsets the temperature setpoint in relation to outdoor temperature in summer and/or winter.

The function is only available when one of the following control types is used:

- √ Constant inlet
- √ Constant extract
- √ Constant room temperature
- √ Note! Is not available when ventilation is controlled by inlet/extract temperature differential.

Winter compensation

- √ Outdoor temperature for start of winter compensation
- √ Outdoor temperature for max. winter compensation
- √ Max. winter compensation of setpoint

Sommer compensation

- √ Outdoor temperature for start of summer compensation
- √ Outdoor temperature for max. summer compensation
- √ Max. summer compensation of setpoint

Installer settings

Setting control functions

Summer/winter changeover

Under the "Installer->Summer/Winter->Changeover" tab, you can choose automatic switching between different operating modes depending on outside temperature.

The function is only available if one of the following temperature control types is used:

- ✓ Constant extract temperature
- ✓ Constant room temperature

The function can be used in applications designed to provide ventilation in winter time and partial or complete room cooling in summer time.

The function switches control type between constant room temperature in summer time and constant inlet temperature in winter time.

Changeover can be set to:

Off

- ✓ The system does not switch between summer and winter operation.

Outdoor temperature

- ✓ Control type changes to summer operation if outdoor temperature is higher than "Changeover temp. summer".
- ✓ Control type changes to winter operation if outdoor temperature is lower than "Changeover temp. winter".

Calendar

- ✓ The system switches between summer and winter operation on certain dates.

Summer

- ✓ Constant summer operation

Winter

- ✓ Constant winter operation

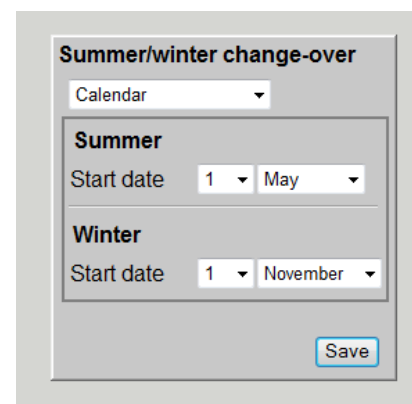
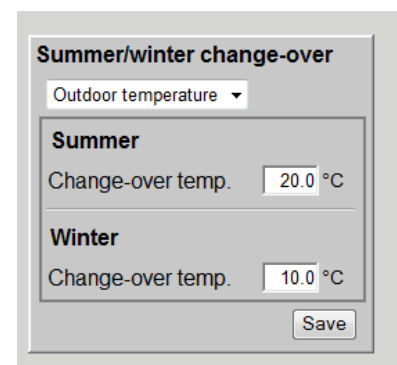
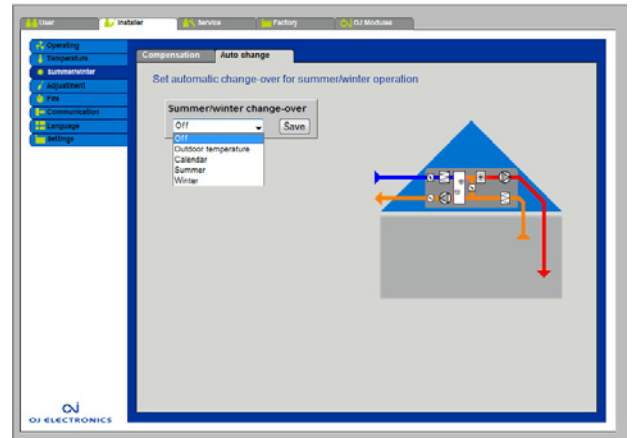

Installer settings

Setting control functions

Adjustment

Under the tab: "Installer->Adjustment->Setpoint", the installer can lock fan speed.

The function, which is used for VAV installations in particular, allows the installer to maintain constant air quantity during system adjustment.

By selecting "Lock", time limits can be selected by clicking the clock.

Time can be set between 2½ and 8 hours.

The function is terminated automatically and the system returns to normal operation after the set time has elapsed.

Speed is frozen at the values set under the "Fire" tab.

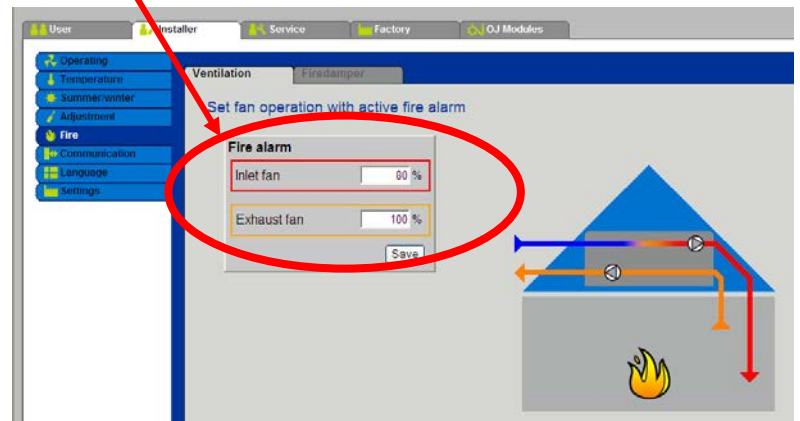
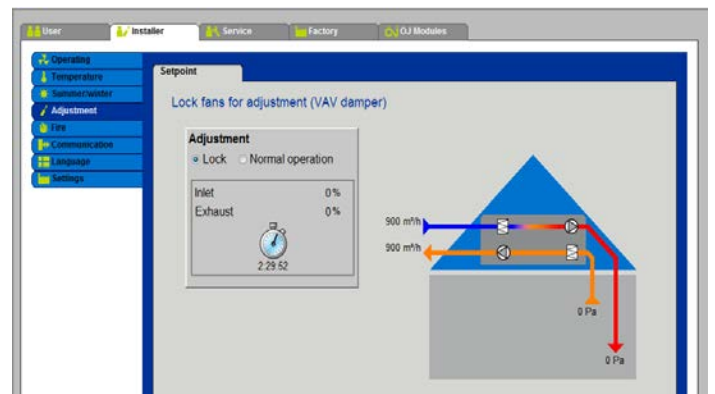

Protection:

Frost protection of the heating battery is active – normal temperature control is not active.

Installer settings

Setting control functions

Fire ventilation (*smoke evacuation*)

This function is used in the case of a fire alarm from, for example, a centralised AFA system.

The function is also suitable for smoke evacuation.

The function is activated by opening the digital input "Fire alarm" (*digital input off*). The system is stopped and a fire alarm sent.

When the "Fire alarm" input is "On", the system operates in normal mode.

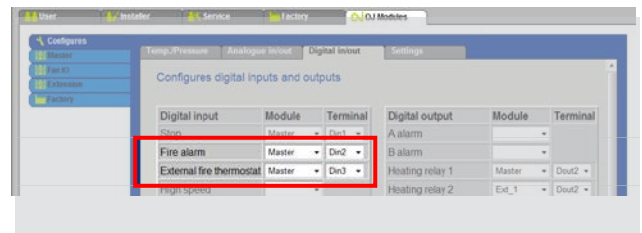

Set fan operation with active fire alarm

- ✓ The fan is forced to the set speed if the fire alarm is activated (***Digital input = "0"***)
- ✓ If "0%" is set for both fans, intake and exhaust dampers will be closed.
- ✓ If just one of the values is >0%, both dampers will be open.

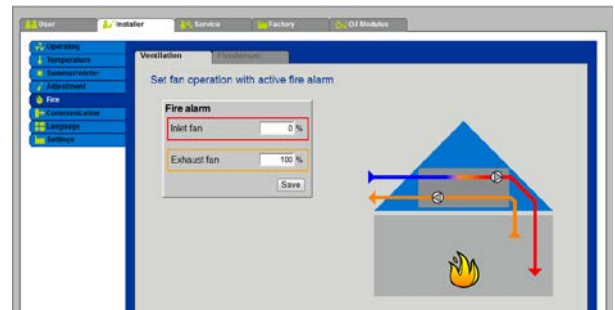

External fire thermostat

- ✓ When the input is activated, the system stops, intake and exhaust dampers are closed and a fire alarm (A-alarm) is activated (***Digital input = "0"***).

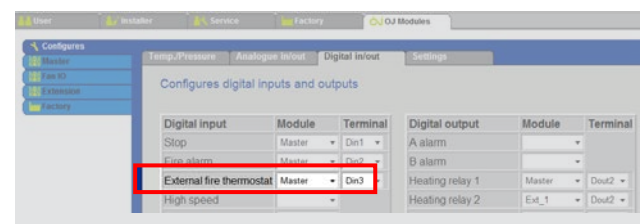

When the "External fire thermostat" input is "On", the system operates in normal mode.

Installer settings

Setting control functions

Test fire dampers

This function is used for systematic function testing of the building's fire dampers. The function disconnects the power supply to the fire dampers, thus closing them. The dampers are closed by means of the "Spring return" function. If smoke evacuation dampers are installed, these will always be in opposite position to the smoke dampers. Wiring diagram: *see following page.*

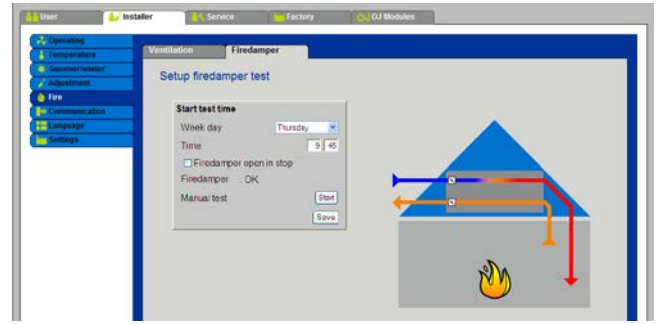

External signals

To test a fire damper, the system uses at least one digital input, which allows the fire damper to respond when closed, and one digital output, which allows a signal to be sent to the fire damper.

If the fire damper does not respond that it is closed to the "Fire damper closed" digital input within 180 seconds, an alarm is activated indicating that the fire damper test failed. The digital input should be connected to the damper motor response switch for closed damper. (See following page for example of electrical wiring diagram.)

Fire damper open

A digital input can also be configured to indicate that the fire damper is open. Only if the digital input for "Fire damper open" receives no response will an alarm be activated for lacking response with open fire damper.

The test is performed in accordance with the set schedule.

When the test is activated, the relay output "Fire damper test" is opened.

Fire damper open during "Stop"

When the system is stopped (e.g. at night), the box can be ticked to specify whether the fire dampers are to be open (box ticked) or closed (box not ticked).

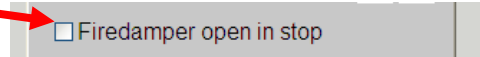

Stop unit on fire damper test errors

- √ If the fire damper test is completed with error, it is possible to select what this error should bring and have of influence on the continuous operation of the air handling unit.



Set testing time

- √ Testing time can be set to:
 - "None" = no pre-set time for fire damper testing.
 - The test can be run by activating "Start" manual test.
 - "Daily"
 - "Every second day"
 - "Monday"... "Sunday"

Set testing time

- √ Time of test

Fire damper

- √ Result of last test

Manual test

- √ Activate to start manual testing



Example of suitable damper motor: Belimo BLF24-ST

Electrical wiring diagram, example:

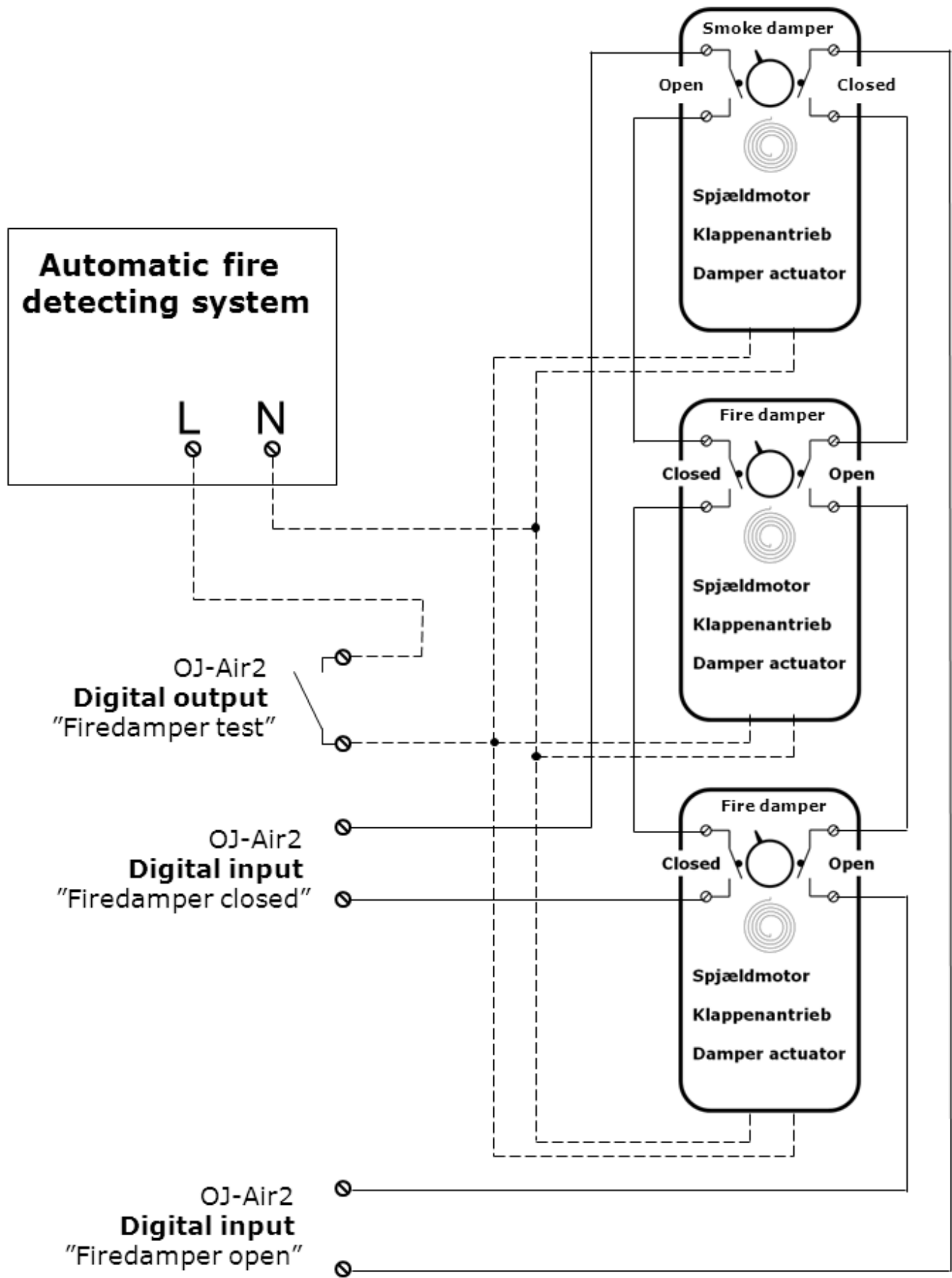

Installer settings

Setting control functions

External communication

Setting communication parameters for TCI/IP, LAN, Web browser and BMS.

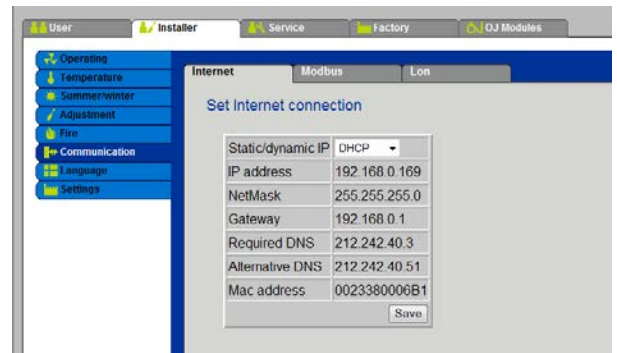

Set Internet connection

Static/Dynamic

- ✓ **DHCP** = IP address assigned from DHCP server on local network or from the Internet.
- ✓ **Static** = the installer must set the following communication parameters:

- IP address
- NetMask
- Gateway
- Required DNS
- Alternative DNS

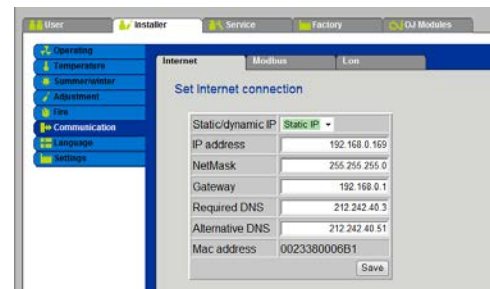

Modbus

Settings for external Modbus RTU

Modbus RTU for external connection of Modbus to BMS system, etc.

- ✓ Modbus address
- ✓ Baud rate (9600, 19200, 38400 baud)
- ✓ Start bit – (setting range: "1" only)
- ✓ Stop bit – (setting range: "1 or 2")
- ✓ Parity – (setting range: "None – Even - Odd")

Finish with "Save".

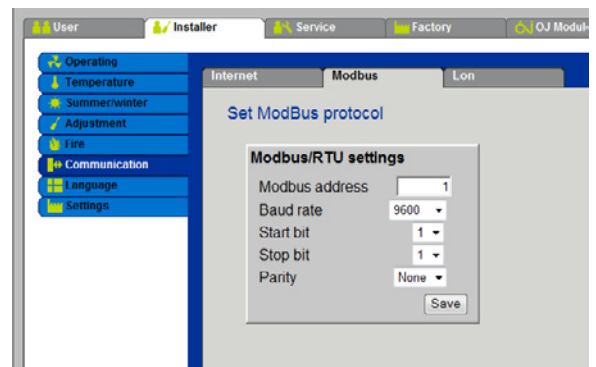

External Modbus RTU must be connected to the "Modbus RS485" connector ->

More information about Modbus RTU:

- Cable length and -type, Terminations, Topology – see under index 1

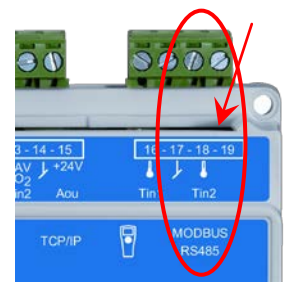

continued next page...

...continued from previous page...

BACnet

Settings for external BACnet connection

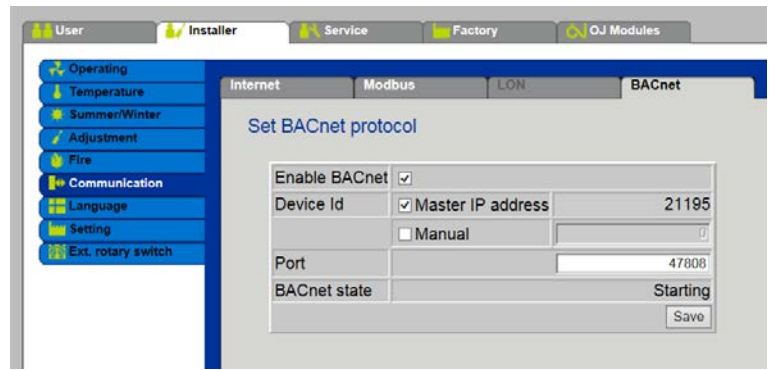

BACnet TCP/IP for external connection to BMS system.

- ✓ Activate BACnet – Factory setting is "Active"
- ✓ Device ID
 - Master IP address
 - BACnet Object Identifier is made from the OJ-Air2Master IP-address.
(see *BACnet protocol documentation*)
 - Manual setting BACnet Object Identifier
- ✓ Port – Setting BACnet Server port
- ✓ BACnet status
- ✓ End with "Save"

External BACnet TCP/IP connect to plug connector "TCP/IP" ----->>>>
Use a standard RJ45 cable

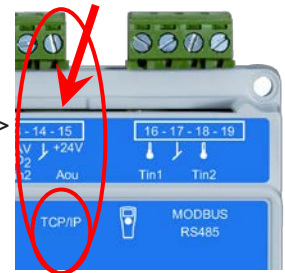

Installer settings

Setting control functions

Setting language

Set language

- ✓ Dansk
- ✓ English
- ✓ Deutsch
- ✓ Svenska
- ✓ Norsk
- ✓ Español
- ✓ Française
- ✓ Polski
- ✓ Русский
- ✓ Italiano
- ✓ Nederlands
- ✓ Suomi Finland



Setting control functions

Installer settings

Settings

Retrieving factory setting



Factory settings can be retrieved by activating the "Retrieve" button. The factory settings which are restored are the factory settings which were saved under "OJ Modules > Factory".

NOTE!

Save factory settings is described under "OJ Modules > Factory"

The same "Save" function can be accessed using the "Save" button, which is described in more detail on the following page...

Restoring factor settings from the hand terminal

Factory settings can also be restored from the menu in the hand terminal.



Setting control functions

Installer settings

Settings

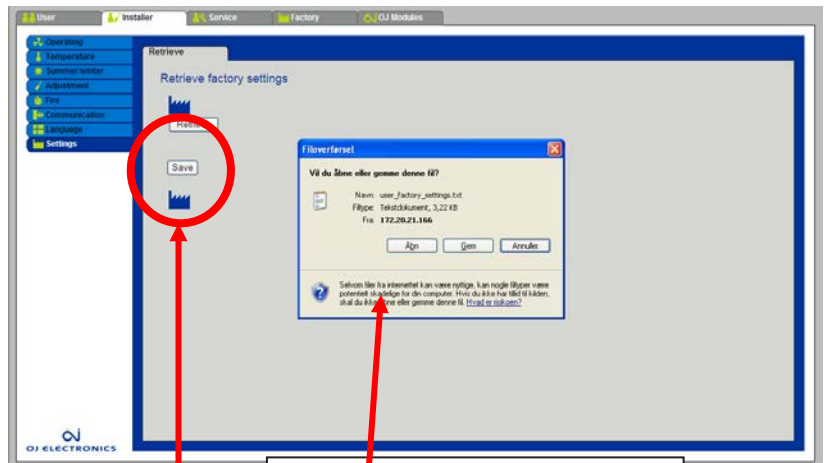

Save factory settings

Factory settings can be saved by activating the "Save" button.

NOTE!

The language used in this dialogue box is the same language as used in your Windows software.

The factory settings are saved as a .txt file and can be saved to a hard disc, server, network, USB stick or standard SD card.

NOTE!

Maximum length of the file name is 50 characters.

No special characters like #, \$, £, %, &, /, =

NOTE!

If factory settings are saved on a standard SD card, it is possible to copy the saved factory settings from the SD card to another OJ-Air2 Master by means of the SD card reader of the OJ-Air2 Master.

Copy function using SD card:

As described above, factory settings can be copied from one OJ-Air2 Master to another using a standard SD card.

To copy factory settings to an OJ-Air2 Master using an SD card, it is important that the SD card only contains a single file with factory settings (*user_factory_settings.txt – the name of the file may be changed, but the file must still have a .txt extension*).

The SD card must only contain one file with a .txt extension.

If the SD card also contains software update files (xxx.tar.gz and xxx.crc), it will be these files which are copied to the OJ-Air2 Master.

Service settings

Setting service functions

Status display

The display shows an overview of the system's actual status and operating conditions.

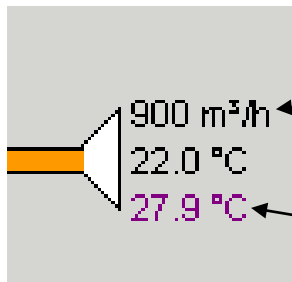
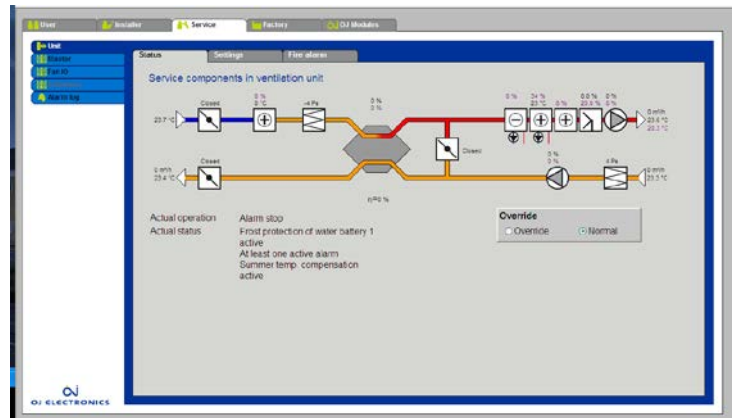

Values with "**black**" text are actual values

Values with "**purple**" text are calculated values

Actual operating conditions and status are described in simple text:

Actual operation	Alarm stop
Actual status	At least one active alarm
	Summer temp. compensation active
	Frost protection of multi-purpose battery active

Service settings

Setting service functions

Override

The function "Override" can be used during service and maintenance to test that the outputs work as intended.

In order to use the override function, the system must be alarm free.
If the system contains active alarms, it is not possible to override the outputs.

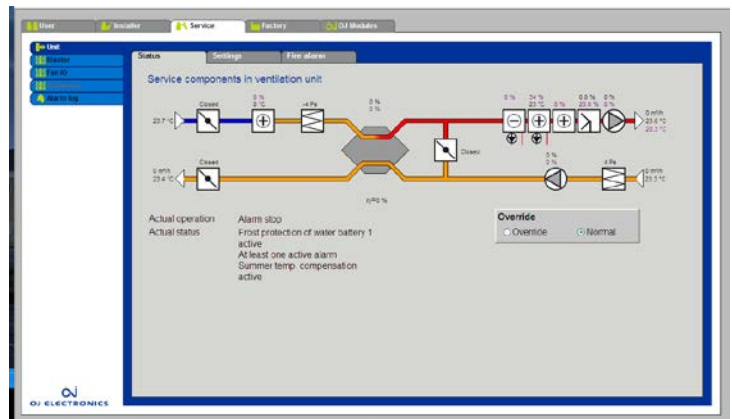

Override of outputs

- ✓ The example illustrates override of supply fan speed.

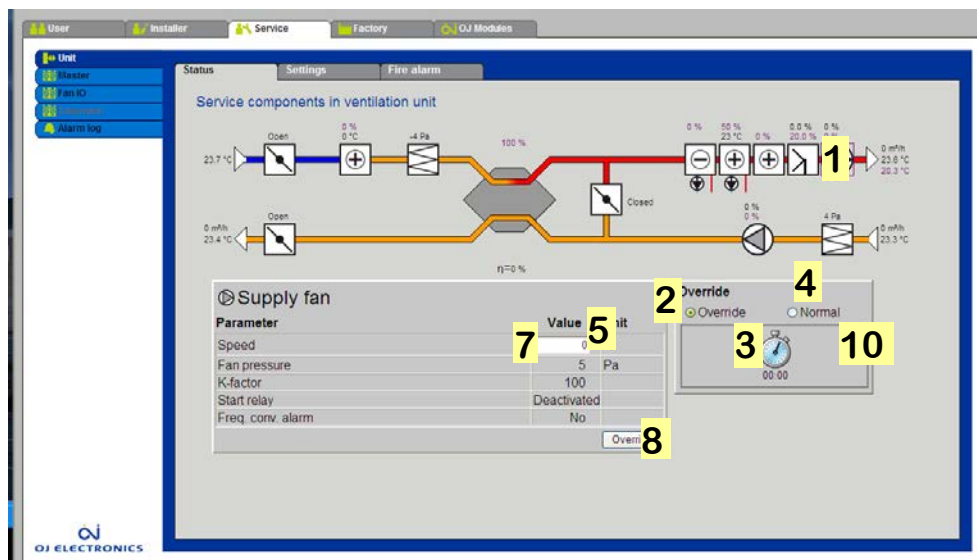

1. Click the component you wish to override manually with the left-hand mouse button.
2. Change control mode from "Normal" to "Override" by clicking "Override" with the left-hand mouse button.
3. Click the clock with the left-hand mouse button to set the length of time override is to remain active.
4. Once the selected period has elapsed, the component concerned will automatically return to "Normal".
5. Click the value in the white field with the left-hand mouse button.
6. In the example shown, the speed of the inlet fan can be overridden.
7. Enter the value with which the component is to be overridden.
8. Finish by clicking the "Override" button with the left-hand mouse button.
9. The component will now operate with the new value as its setpoint. In the example shown, the inlet fan will run at 75% speed.
10. Override is terminated either when the set time has elapsed or by setting control mode back to "Normal".

Service settings

Setting user functions

Status display

Service settings for the individual components of the ventilation system are described in the following.

For individual application components, service parameters are set under:

"Service -> Unit -> Settings"

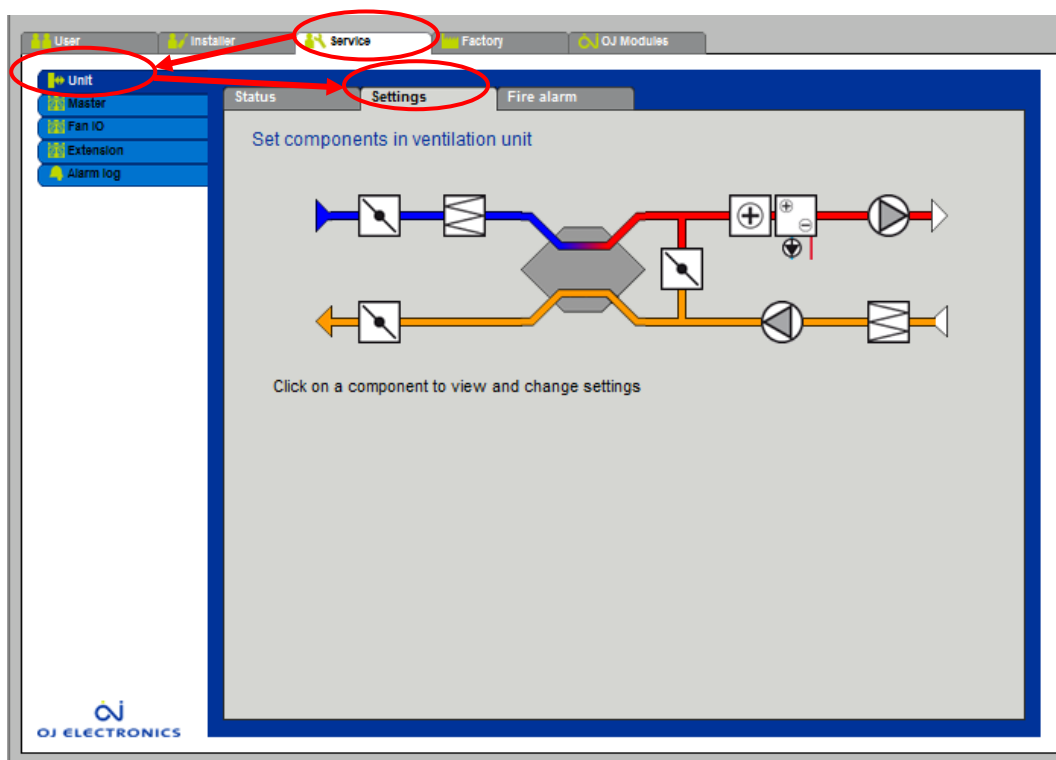

The various components can be set by left-clicking the component with the mouse.

Settings can, for example, be made for:

- √ Heating battery frost protection parameters
- √ Filter monitoring parameters
- √ Control parameters (P-band, I-time)
- √ Heat exchanger ice protection parameters

Possible settings for the various components are described on the following pages.

Service settings

Setting user functions

Setting sensor correction/sensor-offset

Intake sensor

Actual temperature

- ✓ Actual intake temperature

Temperature sensor correction

- ✓ Set the correction/sensor-offset of the intake sensor

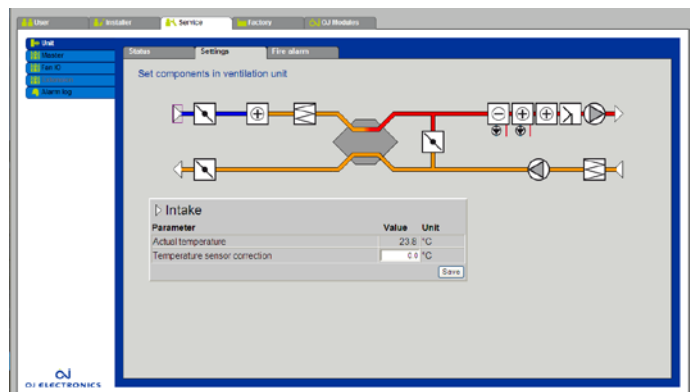

Discharge sensor

Actual temperature

- ✓ Actual discharge temperature

Temperature sensor correction

- ✓ Set the correction/sensor-offset of the discharge sensor

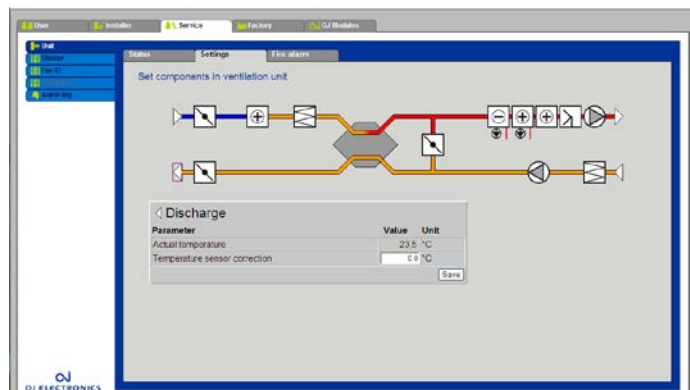

Service settings

Setting components

Setting service parameters for inlet

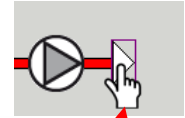

I-time air volume

- ✓ Set control parameter: I-time for control of inlet air volume

The settings below apply to the following control types:

- ✓ Constant inlet
- ✓ Constant inlet/extract differential

P-band heating 1

- ✓ Set control parameter: P-band for "Heating 1" control

P-band cooling

- ✓ Set control parameter: P-band for "Cooling" control

I-time heating 1

- ✓ Set control parameter: I-time for "Heating 1" control

I-time cooling

- ✓ Set control parameter: I-time for "Cooling" control

I-time heat recovery

- ✓ Set control parameter: I-time for "Heat recovery" control

I-time multi-purpose batt.

- ✓ Set control parameter: I-time for "Multi-purpose battery" control

Actual temperature

- ✓ Actual supply air temperature

Temperature sensor correction

- ✓ Set the correction/sensor-offset of the supply air temperature sensor

I-time heating 2

- ✓ Set control parameter: I-time for "Heating 2" control

Finish with "Save".

As a general rule, OJ factory settings will be suitable for most systems.

A screenshot of a software window titled 'Inlet'. It contains a table with columns 'Parameter', 'Value', and 'Unit'. The table lists various control parameters and their current values. A 'Save' button is located at the bottom right of the window.

Parameter	Value	Unit
I-time air volume	50	sec
P-band heating	7.5	°C
P-band cooling	7.5	°C
I-time heating	300	sec
I-time cooling	700	sec
I-time heat recovery	120	sec
I-time multi-purpose batt.	300	sec
Actual temperature	23.9	°C
Temperature sensor correction	0.0	°C
I-time heating 2	300	sec

Service settings

Setting components

Setting service parameters for extract

I-time air volume

- ✓ Set control parameter: I-time for control of extract air volume

The settings below apply to the following control types:

- ✓ Constant extract
- ✓ Constant room

P-band heating 1

- ✓ Set control parameter: P-band for "Heating 1" control

P-band cooling

- ✓ Set control parameter: P-band for "Cooling" control

I-time heating

- ✓ Set control parameter: I-time for "Heating 1" control

I-time cooling

- ✓ Set control parameter: I-time for "Cooling" control

I-time heat recovery

- ✓ Set control parameter: I-time for "Heat recovery" control

I-time multi-purpose batt.

- ✓ Set control parameter: I-time for "Multi-purpose battery" control

Actual temperature

- ✓ Actual exhaust air temperature

Temperature sensor correction

- ✓ Set the correction/sensor-offset of the exhaust air temperature sensor

I-time heating 2

- ✓ Set control parameter: I-time for "Heating 2" control

Finish with "Save".

As a general rule, OJ factory settings will be suitable for most systems.

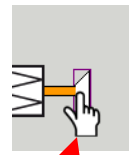

Parameter	Value	Unit
I-time air volume	50	sec
P-band heating	5.0	°C
P-band cooling	5.0	°C
I-time heating	600	sec
I-time cooling	1000	sec
I-time heat recovery	300	sec
I-time multi-purpose batt.	600	sec
Actual temperature	23.6	°C
Temperature sensor correction	0.0	°C
I-time heating 2	600	sec

Service settings

Setting components

Setting service parameters for **inlet fan**

Possible inlet fan settings are identical for the following types of inlet fan:

- ✓ OJ frequency converter
- ✓ OJ-EC Controller
- ✓ 0-10V control of third-party controller (FC/EC)

Delayed start

- ✓ Set delayed start time for the fan.
- ✓ The set time is used for damper opening.

K-factor

- ✓ Set the fan k-factor.
- ✓ Fan k-factor is specified by the fan manufacturer and is used to calculate air volume (m³) according to the following formula:

$$V = \sqrt{\Delta P} \cdot k$$

V = air volume

ΔP= difference between stationary pressure and dynamic pressure across the fan; **k**= fan k-factor



Supply fan		
Parameter	Value	Unit
Delayed start	<input type="text" value="60"/>	sec
K-factor	<input type="text" value="100"/>	
<input type="button" value="Save"/>		

Service settings

Setting components

Setting service parameters for **extract/exhaust fan**

Possible extract fan settings are identical for the following types of extract fan:

- ✓ OJ frequency converter
- ✓ OJ-EC Controller
- ✓ 0-10V control of third-party controller (FC/EC)

Delayed start

- ✓ Set delayed start time for the fan.
- ✓ The set time is used for damper opening

K-factor

- ✓ Set the fan k-factor.
- ✓ Fan k-factor is specified by the fan manufacturer and is used to calculate air volume (m³) according to the following formula:

$$V = \sqrt{\Delta P \cdot k}$$

V = air volume

ΔP= difference between stationary pressure and dynamic pressure across the fan; **k**= fan k-factor

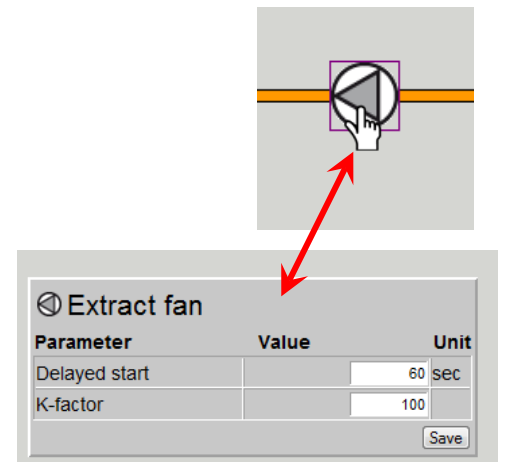

Service settings

Setting components

Setting service parameters for **filter monitoring** with pressure transmitters.

Inlet and extract filters can be set individually.

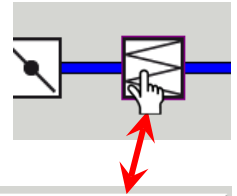

Actual pressure

- ✓ View actual pressure drop across filter

Alarm type

- ✓ Select "**Static**" or "**Dynamic**"
- ✓ "**Static**". A filter alarm (B-alarm) is activated if the alarm limit set under "**Alarm limit static**" is exceeded.
- ✓ "**Dynamic**". A filter alarm (B-alarm) is activated if the pressure drop across the filter exceeds the value (in %) set under "**Alarm limit dynamic**" in relation to a new filter.

Alarm limit static

- ✓ Set the **static** alarm limit for pressure drop across the filter.
Alarm type must be set to "**Static**".

Alarm limit dynamic

- ✓ Set the alarm limit for how much (in %) the pressure drop may be higher than the pressure drop across a new filter.
(Go 2 pages forward in this manual)

Filter pressure reference

- ✓ Filter measurement must be performed when the system is taken into use for the first time and whenever the filter is replaced.

Actual alarm limit

- ✓ Readout of the currently set or calculated alarm limit.

0-calibration

- ✓ Calibration of the system's pressure transmitters.
- ✓ "**Manual**". Click "Calibrate" to 0-calibrate all pressure transmitters in the system.
- ✓ "**Auto**". Select "**Auto**" if all pressure transmitters in the system are to be zero-calibrated every time the system is stopped.

Try calibration

- ✓ View actual time for calibration attempt.

Last calibration

- ✓ View time at which latest zero calibration was performed.

Finish with "Save".

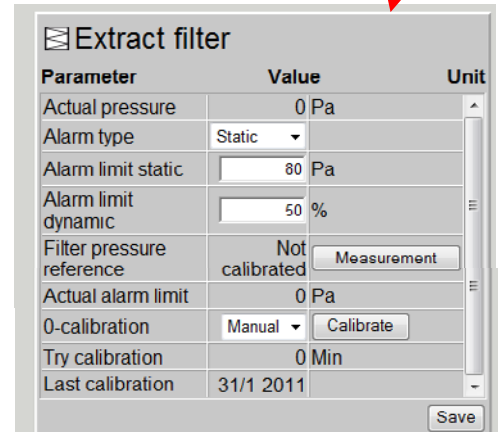

Parameter	Value	Unit
Actual pressure	0 Pa	
Alarm type	Static	
Alarm limit static	80 Pa	
Alarm limit dynamic	50 %	
Filter pressure reference	Not calibrated	<input type="button" value="Measurement"/>
Actual alarm limit	0 Pa	
0-calibration	Manual	<input type="button" value="Calibrate"/>
Try calibration	0 Min	
Last calibration	31/1 2011	

Service settings

Setting components

Setting service parameters for **filter monitoring** with filter pressure switch.

Filter alarm should be set direct on the filter pressure switch.

No settings available from the WEB interface

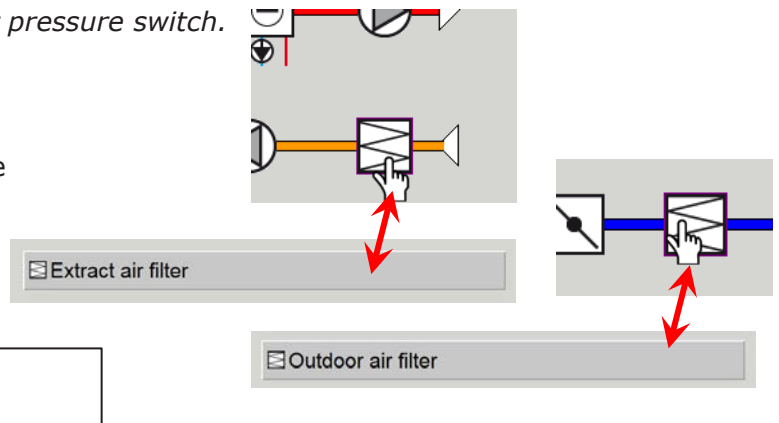

Filteralarm executed on timer limit

Days until filter alarm

- ✓ Read out days until filter alarm

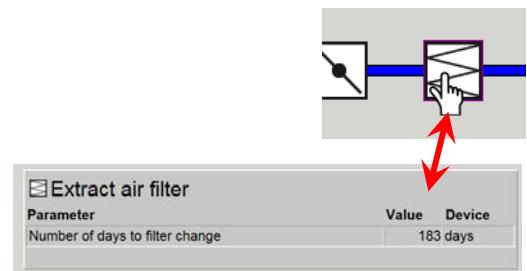

Reset the timer is to be done under "Settings"

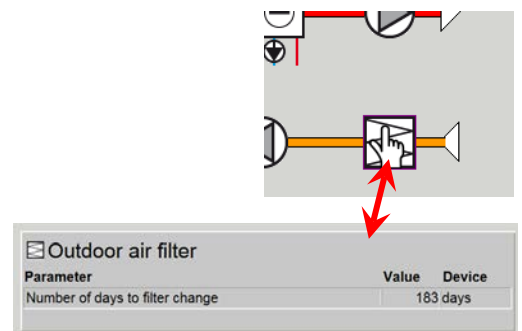

Zero calibration of the pressure transmitters (Zero calibration is to be done under "Settings")

0-calibration

- ✓ 0-calibrating the pressure transmitters in the AHU
- ✓ **"Manual"**. Press "Calibrate" to 0-calibrate all pressure transmitters in "one click"
- ✓ **"Auto"**. Select **"Auto"** if all pressure transmitters are to 0-calibrated after every stop of the AHU.

Try calibration

- ✓ Read out the number of actual calibration tries

Last calibration

- ✓ Read out last calibration time

End with "Save"

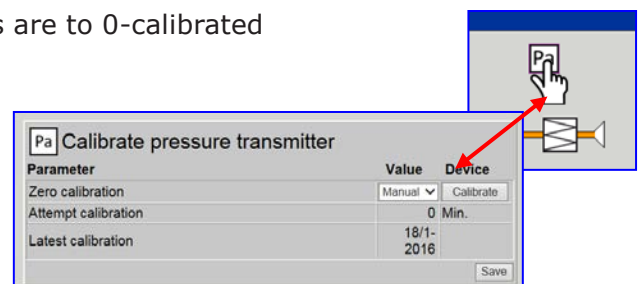

Service settings

Setting components

Description "Dynamic filter monitoring".

The function can be used if the filters are monitored by means of pressure transmitters (PTH-6202, PTH-3202 or OJ-Air2 FanIO).

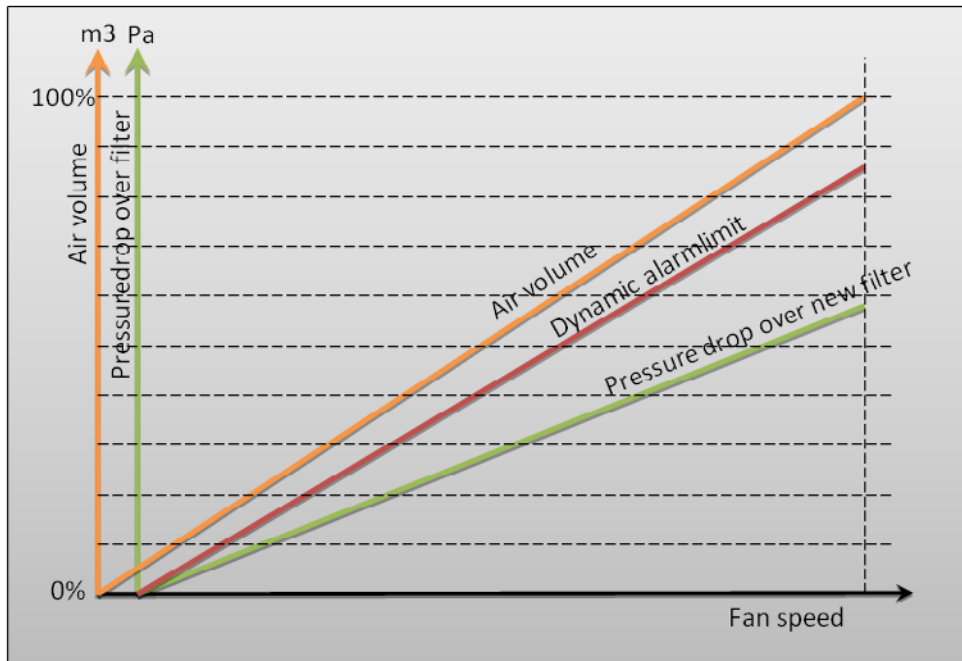

Description "Dynamic filter monitoring".

When "Measurement" is clicked

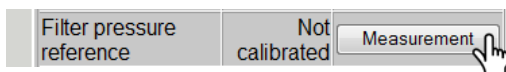

- all fans are stopped.

After all the fans have stopped, they are slowly started again from 0 → 100% (see the orange curve in the diagram) and the pressure drop across the filter is simultaneously recorded.

Pressure drop across the new filter is thus measured and the controls now know the pressure drop characteristics of the new filter (see the green curve in the diagram)

The filter alarm limit can now be set as a percentage increase (see the green curve in the diagram) in relation to the pressure drop across a completely new



When "Measurement" is activated, the procedure is performed for both filters simultaneously.

Measurement need therefore only be performed once for one of the filters.

Service settings

Setting components

Setting service parameters for **preheater**: Water battery .

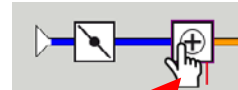

Introduction:

The pre-heating element ensures that the temperature ahead of any heat exchanger is maintained at a required minimum temperature. The sensor is located immediately behind the pre-heating element.

With an hydronic pre-heating battery, a return sensor must always be connected to the heating element return pipe in order to protect the heating battery against frost damage.

If the temperature approaches the setpoint for minimum frost protection temperature (*frost protection control*), the 0-10V heating output will be overridden and more heat provided.

If maximum heat supply is insufficient to maintain the frost protection minimum temperature, a frost alarm will be activated for the pre-heating element and the fans will be stopped.

Parameter	Værdi	Enhed
Setpunkt forvarmer	2.0	°C
Recirkulationspumpe, opstart	Udetemperatur	
Pumpe start	10.0	°C
Frostbeskyttelse regulering	5.0	°C
Minimum temperatur, frostbeskyttelse	2.0	°C
P bånd for frostbeskyttelsesregulering	5.0	°C
Opstarts varme	50.0	%
Standby varme	25.0	°C
Aktuel temperatur (returvand)	0.0	°C

Setpoint preheater

- ✓ Set the preheater setpoint.

Pump operation

- ✓ **"Constant"**. The circulation pump in the heating battery runs constantly when the OJ-Air2 Master is energised.
- ✓ **"Auto"**. The circulation pump in the heating battery runs when heating is required (valve setting > 0.1%).
- ✓ **"Outdoor temperature"**. The circulation pump in the heating battery runs when there is a need for heating – or when the outside temperature drops beneath the value set for the "Pump start" parameter.

Pump exercising

- ✓ If the pump has not been in operation for the last 24 hours, it will be started for one minute regardless of heating demand to prevent pump seizure.

Pump alarm

- ✓ Alarm from pump can be connected to digital input "Heating battery 1 fault" thus activating the pump alarm when the input is opened.

Pump start

- ✓ The pump starts if outdoor temperature is lower than the value set. "Pump operation" must be set to "Outdoor temperature".

Frost protection

- ✓ The value set specifies the return temperature from the water battery at which the valve should be 100% overridden.

Heating valve override starts at the value set plus "Frost P-band" (*see accompanying illustration*).

Frost alarm

- ✓ The value set specifies the return temperature from the water battery at which the system is to stop and activate a frost alarm.

Frost P-band

- ✓ Frost protection of the heating battery starts at the set value plus the value set for the parameter "Frost protection" (*see accompanying illustration*).

Start-up heating

- ✓ During the start-up sequence of the ventilation system, the heating valve will be overridden to the value set. Heating valve override will be terminated once the start-up sequence has been completed and the inlet fan has reached its air volume setting.

Standby heating

- ✓ When the ventilation system is stopped, the heating valve will ensure that return flow from the water battery does not drop below the value set.

Water temperature

- ✓ Displays actual return temperature.

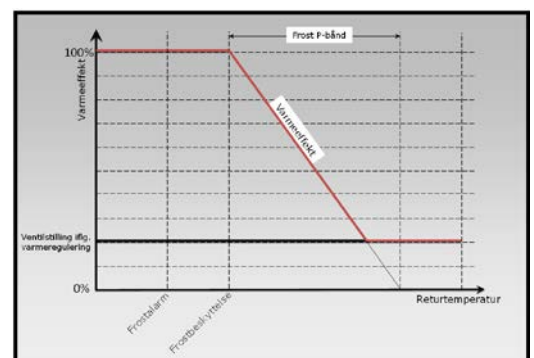

Service settings

Setting components

Setting service parameters for **preheater**: Electrical battery .

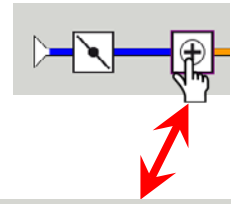

+ Electric battery, preheater		
Parameter	Value	Unit
Setpoint preheater	3.0	°C
Minimum flow for 100% heat power	3000	m³/h
Minimum flow for Electrical battery	1500	m³/h
After cooling time	60	sec.

Save

Setpoint preheater

- ✓ Set the preheater setpoint.

Min. flow, 100% heating

- ✓ The value set specifies the minimum inlet air flow (m³/h) at which the heating step is to be 100% activated.

Min. flow, 0% heating

- ✓ The value set specifies the minimum inlet air flow (m³/h) at which the heating step is to be fully deactivated (0%).

After-cooling time

When the air volume is reduced or stopped completely, there is a risk that the electric heating battery will overheat.

During the after-cooling time, the heating battery is completely deactivated while the fans keep running in accordance with the selected air volume setpoint. The time set specifies the time it takes to remove excess heat from the heating battery.

Electric heating battery monitoring

To prevent the electric battery from overheating, and the consequent risk of fire, the electric battery can be equipped with two protection systems. The two protection systems, which can be used individually or in combination, are described below.

Monitoring of the pre-heating battery in case of overheating or sticking contactor, i.e. the contactor remains active despite having received a cut-out signal. Heating battery overheating protection is connected in series with a contact switch on the contactor to the digital input "Pre-heater alarm". A "Heating battery alarm" is activated if the input is open while electric heating is active (*overheating thermostat*) and a "Contactor sticking" alarm is activated if the input is closed when heating should be inactive.

To ensure air flow through the electric battery before the battery is powered up, an air flow switch can be used (*e.g. ESF-35 from OJ Electronics*). The air flow relay (NO) of ESF-35 should be connected to the digital input "Pre-heater air flow OK"

Electric heating battery monitoring is configured under "Factory settings"

Service settings

Setting service parameters for heating: Water battery 1.

Introduction:

With a water battery, a return sensor **must always** be connected to the heating element return pipe in order to protect the heating element against frost damage.

The sensor can be of the following types:
ETF-598S-3 or ETF-1198SR.

Frost protection consists of P-control based on the frost sensor located in the water battery.

If the temperature approaches the set frost protection minimum temperature of the water, the 0-10V heating output will be overridden and more heat provided.

If maximum heat supply is insufficient to maintain the frost protection minimum temperature, an alarm is activated and the fans are stopped.



Parameter	Value	Unit
Pump operation	Auto	
Pump start	10.0	°C
Frost protection	5.0	°C
Frost alarm	2.0	°C
Frost P-band	5.0	°C
Start up heating	50	%
Standby heating	25.0	°C
Water temperature	25.3	°C
Gain factor, heat 1	100	
Valve setpoint	0.0	%
Test run	Not activ	Start

Pump operation

- ✓ **"Constant"**. The circulation pump in the heating battery runs constantly when the OJ-Air2 Master is energised.
- ✓ **"Auto"**. The circulation pump in the heating battery runs when heating is required (valve setting > 0.1%).
- ✓ **"Outdoor temperature"**. The circulation pump in the heating battery runs when there is a need for heating – or when the outside temperature drops beneath the value set for the "Pump start" parameter.

Pump exercising

- ✓ If the pump has not been in operation for the last 24 hours, it will be started for one minute regardless of heating demand to prevent pump seizure.

Pump alarm

- ✓ Alarm from pump can be connected to digital input "Heating battery 1 fault" thus activating the pump alarm when the input is opened.

Pump start

- ✓ The pump starts if outdoor temperature is lower than the value set. "Pump operation" must be set to "Outdoor temperature".

Frost protection

- ✓ The value set specifies the return temperature from the water battery at which the valve should be 100% overridden.
Heating valve override starts at the value set plus "Frost P-band" (*see accompanying illustration*).

Frost alarm

- ✓ The value set specifies the return temperature from the water battery at which the system is to stop and activate a frost alarm.

Frost P-band

- ✓ Frost protection of the heating battery starts at the set value plus the value set for the parameter "Frost protection" (*see accompanying illustration*).

Start-up heating

- ✓ During the start-up sequence of the ventilation system, the heating valve will be overridden to the value set. Heating valve override will be terminated once the start-up sequence has been completed and the inlet fan has reached its air volume setting.

Standby heating

- ✓ When the ventilation system is stopped, the heating valve will ensure that return flow from the water battery does not drop below the value set.

Water temperature

- ✓ Displays actual return temperature.

Gainfactor, heat 1

- ✓ Set gain factor for heating battery

Valve setpoint

- ✓ Actual setpoint of the connected Direct Modbus valve

Test run, heating1 (only relevant with Direct Modbus actuators)

- ✓ Press "Start" to begin a sequence of tests of the connected Direct Modbus valve.

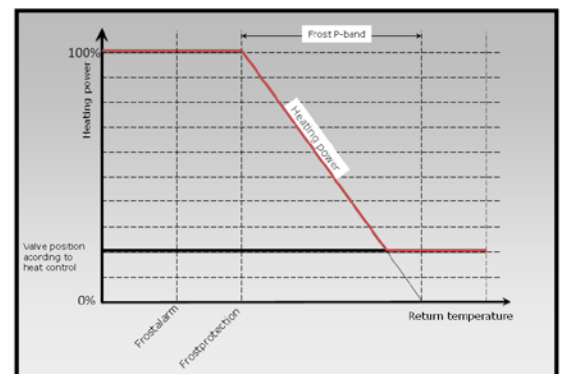

Service settings

Setting components

Setting service parameters for heating: Electric battery 1

Introduction:

The electric heating battery can be controlled either via a 0-10V signal from an analogue output or via digital relay outputs. When digital outputs are used, the heating battery can be controlled by one or two digital outputs and control type can be set to:

- ✓ 0-10V
- ✓ 1-step (digital relay output)
- ✓ 2-step (digital relay output)
- ✓ Binary via two relay outputs

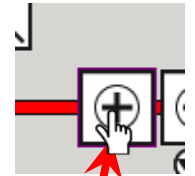

Electric battery 1		
Parameter	Value	Unit
Control type	0-10 V	
Min. flow, 100% heating	900	m ³ /h
Min. flow, 0% heating	400	m ³ /h
After-cooling time	60	sec

Save

Control type

- ✓ **"0-10V"** - analogue heating control is connected to an analogue 0-10V output (e.g. EFS-9XXX).
- ✓ **"1-step"** - the electric heating battery is controlled in one step (On/Off).
- ✓ **"2-step"** - the electric heating battery is controlled in two steps (On/Off).
When heating demand rises, "Heating relay 1" is activated first, followed by "Heating relay 2".
When heating demand falls, "Heating relay 2" is deactivated first, followed by "Heating relay 1".
- ✓ **"Binary"** - electric heating battery binary controlled in three steps (On/Off).
Heating elements in the heating battery must be sized 1/3 - 2/3.

When heating demand rises:

- "Heating relay 1" is activated
- "Heating relay 2" is activated and "Heating relay 1" is deactivated
- "Heating relay 1" and "Heating relay 2" are both activated

When heating demand falls:

- "Heating relay 1" is deactivated
- "Heating relay 2" is deactivated and "Heating relay 1" is activated
- "Heating relay 1" and "Heating relay 2" are both deactivated

Min. flow, 100% heating

- ✓ The value set specifies the minimum inlet air flow (m³/h) at which the heating step is to be 100% activated.

Min. flow, 0% heating

- ✓ The value set specifies the minimum inlet air flow (m³/h) at which the heating step is to be fully deactivated (0%).

After-cooling time

When the air volume is reduced or stopped completely, there is a risk that the electric heating battery will overheat.

During the after-cooling time, the heating battery is completely deactivated while the fans keep running in accordance with the selected air volume setpoint. The time set specifies the time it takes to remove excess heat from the heating battery.

Heating battery monitoring

- ✓ Monitoring of the heating battery in case of overheating or sticking contactor, i.e. the contactor remains active despite having received a cut-out signal. Heating battery overheating protection is connected in series with a make-contact switch on the contactor to the digital input "Heating battery 1 fault". A "Heating battery alarm" is activated if the input is open while heating is active and a "Contactor sticking" alarm if the input is closed when heating should be inactive.

Service settings

Setting service parameters for heating: Water battery 2.

Introduction:

With a water battery, a return sensor **must always** be connected to the heating element return pipe in order to protect the heating element against frost damage.

The sensor can be of the following types:

ETF-598S-3 or ETF-1198SR.

Frost protection consists of P-control based on the frost sensor located in the water battery.

If the temperature approaches the set frost protection minimum temperature of the water, the 0-10V heating output will be overridden and more heat provided.

If maximum heat supply is insufficient to maintain the frost protection minimum temperature, an alarm is activated and the fans are stopped.



Parameter	Value	Unit
Pump operation	Outdoor temperature	
Pump start	15.0	°C
Pump start	25	%
Frost protection	5.0	°C
Frost alarm	2.0	°C
Frost P-band	5.0	°C
Start up heating	50	%
Standby heating	25.0	°C
Water temperature	0.0	°C
Motorvalve	0-10V	
Gain factor_heat 2	100	

Pump operation

- ✓ **"Constant"**. The circulation pump in the heating battery runs constantly when the OJ-Air2 Master is energised.
- ✓ **"Auto"**. The circulation pump in the heating battery runs when heating is required (valve setting > 0.1%).
- ✓ **"Outdoor temperature"**. The circulation pump in the heating battery runs when there is a need for heating – or when the outside temperature drops beneath the value set for the "Pump start" parameter.

Pump exercising

- ✓ If the pump has not been in operation for the last 24 hours, it will be started for one minute regardless of heating demand to prevent pump seizure.

Pump alarm

- ✓ Alarm from pump can be connected to digital input "Heating battery 1 fault" thus activating the pump alarm when the input is opened.

Pump start

- ✓ The pump starts if outdoor temperature is lower than the value set. "Pump operation" must be set to "Outdoor temperature".

Frost protection

- ✓ The value set specifies the return temperature from the water battery at which the valve should be 100% overridden.
Heating valve override starts at the value set plus "Frost P-band" (*see accompanying illustration*).

Frost alarm

- ✓ The value set specifies the return temperature from the water battery at which the system is to stop and activate a frost alarm.

Frost P-band

- ✓ Frost protection of the heating battery starts at the set value plus the value set for the parameter "Frost protection" (*see accompanying illustration*).

Start-up heating

- ✓ During the start-up sequence of the ventilation system, the heating valve will be overridden to the value set. Heating valve override will be terminated once the start-up sequence has been completed and the inlet fan has reached its air volume setting.

Standby heating

- ✓ When the ventilation system is stopped, the heating valve will ensure that return flow from the water battery does not drop below the value set.

Water temperature

- ✓ Displays actual return temperature.

Motorvalve

- ✓ Set the control signal for the motor valve (0-10V/2-10V)

Gainfactor, heat 2

- ✓ Set gain factor for heating battery

Valve setpoint

- ✓ Actual setpoint of the connected Direct Modbus valve

Test run, heating1 (only relevant with Direct Modbus actuators)

- ✓ Press "Start" to begin a sequence of tests of the connected Direct Modbus valve.

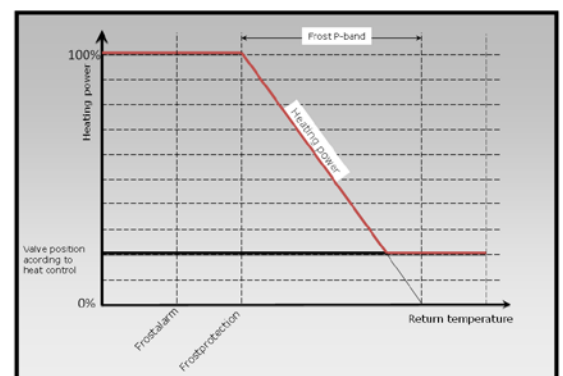

Service settings

Setting components

Setting service parameters for heating: **Electric battery 2**

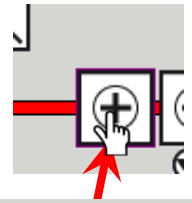

Introduction:

The electric heating battery can be controlled either via a 0-10V signal from an analogue output or via digital relay outputs. When digital outputs are used, the heating battery can be controlled by one or two digital outputs and control type can be set to:

- ✓ 0-10V
- ✓ 1-step (digital relay output)
- ✓ 2-step (digital relay output)
- ✓ Binary via two relay outputs

Electric battery 2		
Parameter	Value	Unit
Control type	0-10 V	
Min. flow, 100% heating	3000	m ³ /h
Min. flow, 0% heating	1500	m ³ /h
After-cooling time	60	sec
Gain factor, heat 2	100	

Save

Control type

- ✓ **"0-10V"** - analogue heating control is connected to an analogue 0-10V output (e.g. EFS-9XXX).
- ✓ **"1-step"** - the electric heating battery is controlled in one step (On/Off).
- ✓ **"2-step"** - the electric heating battery is controlled in two steps (On/Off).
When heating demand rises, "Heating relay 1" is activated first, followed by "Heating relay 2".
When heating demand falls, "Heating relay 2" is deactivated first, followed by "Heating relay 1".
- ✓ **"Binary"** - electric heating battery binary controlled in three steps (On/Off).
Heating elements in the heating battery must be sized 1/3 - 2/3.

When heating demand rises:

- "Heating relay 1" is activated
- "Heating relay 2" is activated and "Heating relay 1" is deactivated
- "Heating relay 1" and "Heating relay 2" are both activated

When heating demand falls:

- "Heating relay 1" is deactivated
- "Heating relay 2" is deactivated and "Heating relay 1" is activated
- "Heating relay 1" and "Heating relay 2" are both deactivated

Min. flow, 100% heating

- ✓ The value set specifies the minimum inlet air flow (m³/h) at which the heating step is to be 100% activated.

Min. flow, 0% heating

- ✓ The value set specifies the minimum inlet air flow (m³/h) at which the heating step is to be fully deactivated (0%).

After-cooling time

When the air volume is reduced or stopped completely, there is a risk that the electric heating battery will overheat.

During the after-cooling time, the heating battery is completely deactivated while the fans keep running in accordance with the selected air volume setpoint. The time set specifies the time it takes to remove excess heat from the heating battery.

Heating battery monitoring

- ✓ Monitoring of the heating battery in case of overheating or sticking contactor, i.e. the contactor remains active despite having received a cut-out signal. Heating battery overheating protection is connected in series with a make-contact switch on the contactor to the digital input "Heating battery 1 fault". A "Heating battery alarm" is activated if the input is open while heating is active and a "Contactor sticking" alarm if the input is closed when heating should be inactive.

Service settings

Setting components

Setting service parameters for cooling: DX cooling

Introduction:

DX cooling can be configured to control from one to four compressors or cooling levels. The OJ-Air2 system starts and stops cooling according to demand and activates an alarm if there are problems with the cooling circuit. Compressors are started/stopped via four digital outputs.

DX cooling cannot be configured with analogue outputs.

Pressure transmitters must be installed in the cooling circuit in order to measure high and low pressure in the DX pressure circuit.

With digital output control, the cooling compressors can be controlled by one, two, three or four digital outputs and the control type must be set to:

- √ 2-step
- √ 3-step binary
- √ 4-step
- √ 15-step binary

Control type – DX cooling battery in control form

- ✓ **"2-step"** – cooling is controlled in two steps (2 x digital On/Off).

*When cooling demand rises, "Cooling relay 1" is activated first, followed by "Cooling relay 2".
When cooling demand falls, "Cooling relay 2" is deactivated first, followed by "Cooling relay 1".*

- ✓ **"3-step binary"** – the DX cooling compressor is controlled in binary fashion in three steps (On/Off). The output ratio between the two compressors must be 1/3 - 2/3.

- ✓ When cooling demand rises:
 - o "Cooling relay 1" is activated
 - o "Cooling relay 2" is activated and "Cooling relay 1" is deactivated
 - o "Cooling relay 1" and "Cooling relay 2" are both activated

When cooling demand falls:

- o "Cooling relay 1" is deactivated
- o "Cooling relay 2" is deactivated and "Cooling relay 1" is activated
- o "Cooling relay 1" and "Cooling relay 2" are both deactivated

2-step and 3-step binary require that two digital outputs are configured.

- ✓ **"4-step"** – cooling is controlled in four steps (4 x digital On/Off).
When cooling demand rises, "Cooling relay 1" is activated first, followed by "Cooling relay 2", followed by "Cooling relay 3" and followed finally by "Cooling relay 4".

When cooling demand falls, "Cooling relay 4" is deactivated first, followed by "Cooling relay 3", followed by "Cooling relay 2" and followed finally by "Cooling relay 1".

- ✓ **"15-step binary"** – the four digital outputs are connected in binary fashion as 1 + 2 + 4 + 8 and the output relation between cooling steps must therefore also be 1 + 2 + 4 + 8.

...continued on following page...

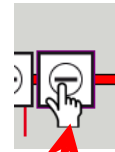

Parameter	Value	Unit
Control	2-step	
Min. air volume	400	m³/h
Min. cooling time	0	sec
Max. restarts per hour	10	
After cooling time	60	sec
Low pressure circuit 1 alarm	3	Bar
High pressure circuit 1 alarm	15	Bar
Low pressure circuit 2 alarm	3	Bar
High pressure circuit 2 alarm	15	Bar

Save

Service settings

Setting components

Setting service parameters for cooling: DX cooling

...continued from previous page...

Min. air volume

- ✓ Cooling is blocked at lower air volumes

Min. cooling time

- ✓ Minimum operating time per start for the individual compressor

Max. restarts per hour

- ✓ Max. no of restarts per hour

After-cooling time

- ✓ When the system is stopped, the condenser will continue to be cooled by the extract fan for the set number of seconds.

Low pressure circuit 1 alarm

- ✓ A B-alarm is activated at lower condenser pressure in circuit 1.

High-pressure circuit 1 alarm

- ✓ A B-alarm is activated at higher condenser pressure in circuit 1.

Low pressure circuit 2 alarm

- ✓ A B-alarm is activated at lower condenser pressure in circuit 2.

High-pressure circuit 2 alarm

- ✓ A B-alarm is activated at higher condenser pressure in circuit 2.

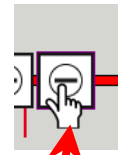

Parameter	Value	Unit
Control	2-step	
Min. air volume	400	m ³ /h
Min. cooling time	0	sec
Max. restarts per hour	10	
After cooling time	60	sec
Low pressure circuit 1 alarm	3	Bar
High pressure circuit 1 alarm	15	Bar
Low pressure circuit 2 alarm	3	Bar
High pressure circuit 2 alarm	15	Bar

Save

Service settings

Setting components

Setting service parameters for Cooling: Water cooling

Introduction:

Water cooling is configured to control an analogue valve in the water circuit via a configured 0-10V output.

Start/stop of circulation pump in cooling circuit via digital output.

Alarm from pump can be connected to digital input "Cooling fault" thus activating the pump alarm when the input is opened.

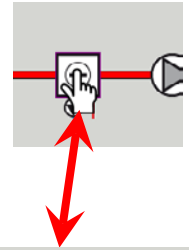

Water cooling		
Parameter	Value	Unit
Pump operation	Outdoor temperature	
Pump start	21.0	°C
Valve setpoint	0.0	%
Test run	Not activ	<input type="button" value="Start"/>
<input type="button" value="Save"/>		

Pump operation

- ✓ **"Constant"**. The circulation pump in the cooling battery runs constantly when the OJ-Air2 Master is energised.
- ✓ **"Auto"**. The circulation pump in the cooling battery runs when cooling is required (valve setting > 0.1%).
- ✓ **"Outdoor temperature"**. The circulation pump in the cooling battery runs when there is a need for cooling – or when the outside temperature rises above the value set for the "Pump start" parameter.

Pump start

- ✓ The pump starts if outdoor temperature is higher than the value set. "Pump operation" must be set to "Outdoor temperature".

Valve setpoint

- ✓ Actual setpoint of the connected Direct Modbus valve

Test run, heating1 (only relevant with Direct Modbus actuators)

- ✓ Press "Start" to begin a sequence of tests of the connected Direct Modbus valve.

Service settings

Setting components

Setting service parameters for cooling/heating: Multi-purpose battery

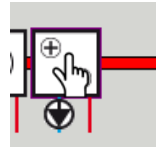

Introduction:

A multi-purpose battery is a heating and cooling element combined in a single unit. A multi-purpose battery can either heat or cool depending on the signals it receives from the controls. A multi-purpose battery is equipped with only one modulating 0-10V valve motor and is controlled by one and the same analogue output for both heating and cooling.

When heating is demanded, the analogue output is controlled in a modulated fashion from 0-100% and the circulation pump is started via a digital output. When cooling is demanded, the analogue output is controlled in a modulated fashion from 0-100% and the circulation pump is started via a digital output.

The circulation pump in the cooling/heating circuit is started/stopped via a digital output.

A pump alarm can be connected to digital input "Multi-purpose battery alarm" thus activating the pump alarm when the input is opened.

Parameter	Value	Unit
Pump operation	Auto	
Pump start heat	10.0	°C
Pump start cool	22.0	°C
Frost protection heat	5.0	°C
Frost alarm heat	2.0	°C
Frost alarm cool	2.0	°C
Frost P-band	5.0	°C
Start up heating	50	%
Standby heating	25.0	°C
Water temperature	0.0	°C
Gain factor multi-purpose battery	100	

Analog cooling output sequential

- ✓ **"No"**: Only one analog output (**Cooling**) for cooling signal is active in the cooling sequence.
- ✓ **"Yes"**: 2 Analog output (**Cooling + Cooling2 Multi purpose**) is activated in sequence after each other

Pump operation

- ✓ **"Constant"**. The circulation pump in the multi-purpose battery runs constantly when the OJ-Air2 Master is energised.
- ✓ **"Auto"**. The circulation pump in the multi-purpose battery runs when cooling or heating is required (valve setting > 0.1%).
- ✓ **"Outdoor temperature"**.. The circulation pump in the multi-purpose battery runs when there is a need for cooling or heating – or when the outside temperature rises above the value set for the "Pump start" parameter.

Pump start heat

- ✓ The pump starts if outdoor temperature is higher than the value set. "Pump operation" must be set to "Outdoor temperature".

Pump start cool

- ✓ The pump starts if outdoor temperature is higher than the value set. "Pump operation" must be set to "Outdoor temperature".

Frost protection heat

- ✓ Set the temperature of the return flow from the multi-purpose battery at which the heating valve is to be 100% overridden in order to protect the multi-purpose battery from frost damage. The function is only active when heating is demanded.

Frost alarm heat

- ✓ Set the temperature of the return flow at which the system is to stop, close dampers and activate the frost alarm. The heating valve remains open as long as the temperature remains below the value set. The function is only active when heating is demanded.

Frost alarm cool

- ✓ Set the temperature of the return flow at which the system is to stop, close dampers and activate the frost alarm. The heating valve remains closed as long as the temperature remains below the value set. The function is only active when cooling is demanded.

Frost P-band

- ✓ Frost protection of the multi-purpose battery starts at the set value plus the value set for the parameter "Frost protection heating" (see accompanying illustration).

Start-up heating

- ✓ During the start-up sequence of the ventilation system, the heating valve will be overridden to the value set. Heating valve override will be terminated once the start-up sequence has been completed and the inlet fan has reached its air volume setting.

Standby heating

- ✓ When the ventilation system is stopped, the heating valve will ensure that return flow from the water battery does not drop below the value set.

Water temperature

- ✓ Displays actual return temperature.

Gainfactor, multi-purpose battery

- ✓ Set gain factor for heating battery

Heating/cooling release via Modbus

- ✓ **"NO"**: Release heating/cooling via digital inputs (see index 4, "Modules"/Digital inputs)
- ✓ **"Yes"**: Release heating/cooling via Modbus registers (see index 11, "Modbus protocol")

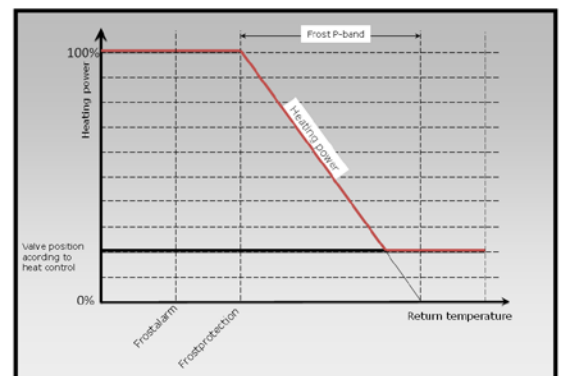

Setting components

Service settings

Setting service parameters for **adiabatic cooling**

Adiabatic cooling

In general:

Adiabatic cooling is a cooling form which uses atomized water in the extract air just before it passes through the heat exchanger.

By taking advantage of the evaporation and the released cooling power generated in this evaporative process, the heat exchanger is transferring cooling energy to the supply air.

Cooling power is to be controlled by an pulse/pause signal to the evaporator valve..

To optimize the evaporation process an minimum airflow is necessary.

This minimum can be set in the controller under "Settings"

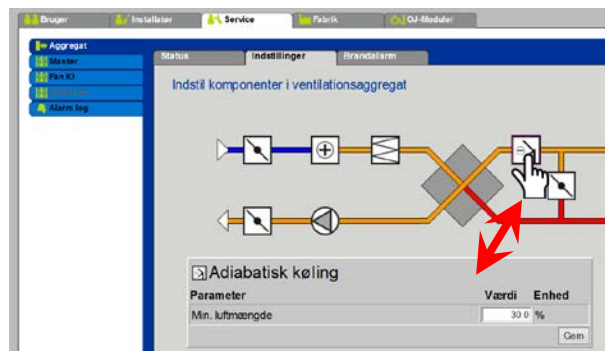

Security

To avoid too much cooling, water damage and/or flooding in the unit, there is a security feature which allows you to set the maximum operating time of atomizer / water*valve during startup.

*= *This settings can be made under "Factory settings"*

Settings

Min. Air volume in percent

- ✓ Set the minimum air volume – cooling will be blocked by air volumes under the value.
- ✓ Values in this parameter is in % of the maximum unit airflow capacity.

Service settings

Setting components

Setting service parameters for **humidifier**.

Introduction:

The humidifier can add moisture to the inlet air in the form of steam or atomised water depending on the chosen setpoint and on the actual humidity measured by the humidity sensor.

A humidifier is controlled by means of a 0-10 V control signal from the controller and a digital start/stop signal to the humidifier.

When moisture is demanded, the analogue output is controlled in a modulated fashion from 0-100% and the humidifier is started via a digital output.

An alarm from the humidifier can be connected to the digital input "Humidifier, Alarm", allowing a humidifier alarm (alarm no. 197) to be activated when the input is opened.

Parameter

- ✓ "Humidity setpoint". Adjustment of setpoint for inlet air humidity.
- ✓ "Controller signal". Output signal from humidity controller (internal signal)
- ✓ "Humidity output signal". Output signal to humidifier
- ✓ "Humidity actual". Actual humidity in inlet duct
- ✓ "P-band". P-band for humidity controller
- ✓ "I-time". I-time for humidity controller.

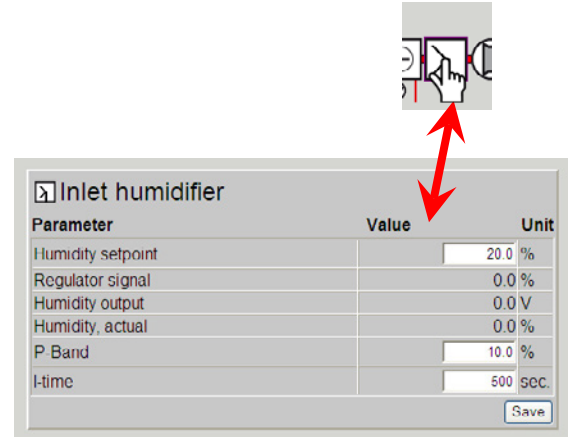

Service settings

Setting components

Setting service parameters for Heat recovery: Cross-flow heat exchanger

Introduction:

A cross-flow heat exchanger is controlled via a modulating 0-10V signal from the OJ-Air2 system. The damper motor (or motors) of the exchanger/bypass damper must be capable of being controlled by a modulating 0-10V signal.

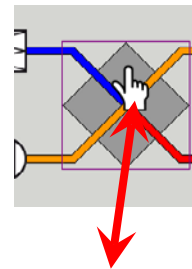

The cross-flow heat exchanger is protected against ice formation by recording the temperature of the exhaust air after the extract air has passed the heat exchanger.

Cross-flow heat exchanger		
Parameter	Value	Unit
Ice protection	5.0	°C
Ice protection P-band	5.0	°C
Gain factor, heat recovery	100	
Damper setpoint	0.0	%
Test run	Not active	<input type="button" value="Start"/>
Alarm at low efficiency	No	
Correction factor, heat exchanger efficiency	0.0	%
Alarm level, efficiency	70	%

Ice protection

- ✓ At temperatures below the value set plus P-band, the bypass damper will be opened in a modulated fashion to 100% open. Fresh air thus bypasses the cross-flow heat exchanger while the air extracted from the room is passed through the exchanger. Because of the relatively high room temperature, this function will thaw the ice deposited on the cross-flow heat exchanger.

Ice protection P-band

- ✓ At temperatures below the value set plus the value set for the "Ice protection" parameter, the bypass damper will be opened in a modulated fashion to 100% open.

Gain factor, cross-flow heat exchanger

- ✓ Set gain factor for cross-flow heat exchanger

Damper cross-flow heat exchanger (only relevant with Direct Modbus actuators)

- ✓ Expected damper position.

Test run, bypass damper (only relevant with Direct Modbus actuators)

- ✓ Press "Start" to begin a sequence of tests of the connected Direct Modbus damper.

Alarm due to low efficiency

- ✓ Select whether an alarm is to be activated at low efficiency.

Efficiency correction factor

- ✓ Set correction factor for efficiency calculation.

Alarm level, efficiency

- ✓ Set alarm limit for low efficiency alarm.
- ✓ In order for the alarm to be activated, the system must be in "Operating" status, efficiency must be lower than the value set and the parameter "Alarm at low efficiency" must be set to "Yes".

Service settings

Setting components

Setting service parameters for heat recovery: Rotary heat exchanger with RHX2M

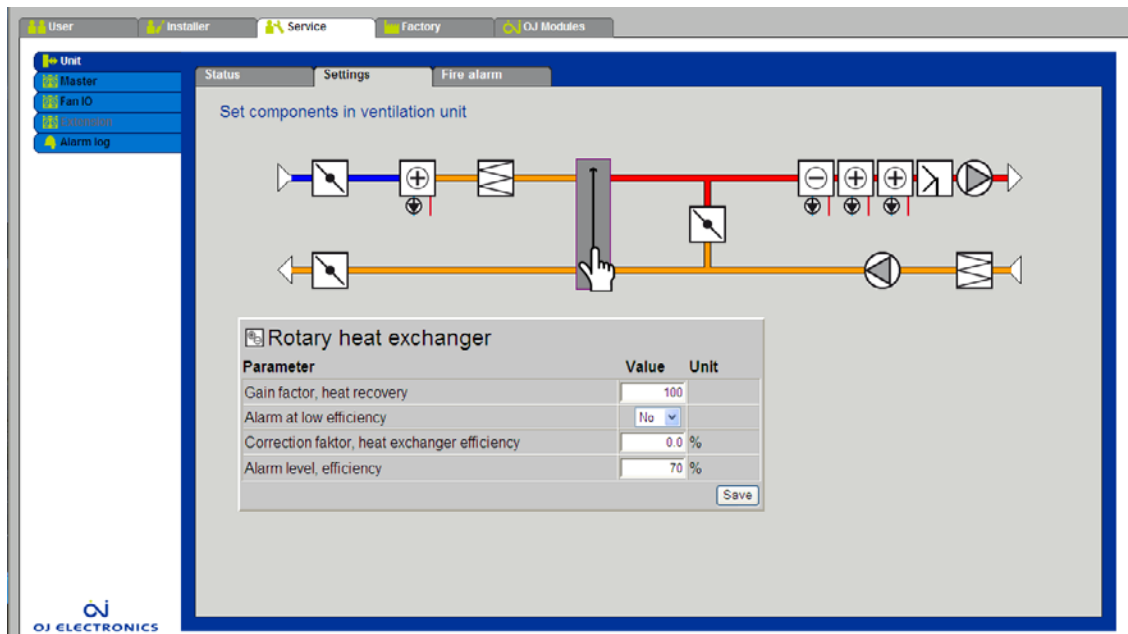

Introduction:

The rotary heat exchanger is controlled either by a modulating 0-10V signal or by Modbus. The rotary heat exchanger can only be controlled by Modbus if the rotary heat exchanger controls are type RHX2M from OJ Electronics.

Control of rotary heat exchanger with RHX2M

Parameters for RHX2M are accessible under: "Factory -> Configuration -> Electric".

Gain factor, rotary heat exchanger

- ✓ Set gain factor for rotary heat exchanger

Alarm due to low efficiency

- ✓ Select whether an alarm is to be activated at low efficiency.

Efficiency correction factor

- ✓ Set correction factor for efficiency calculation.

Alarm level, efficiency

- ✓ Set alarm limit for low efficiency alarm.
- ✓ In order for the alarm to be activated, the system must be in "Operating" status, efficiency must be lower than the value set and the parameter "Alarm at low efficiency" must be set to "Yes".

Service settings

Setting components

Setting service parameters for heat recovery: Fluid-coupled heat recovery

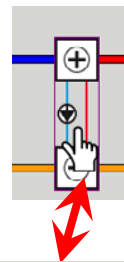

Introduction

OJ-Air2 can control fluid-coupled heat recovery by means of the following:

· Outputs

Analogue output "Heat recovery" (0-10V)
Digital output "Heating relay 2" (pump relay)

· Inputs

Recovery sensor "Recovery fluid temp."
The sensor is physically located in direct contact with the outlet from the hot recovery element.

Pump operation

- ✓ **"Constant"**. The circulation pump in the heat recovery battery runs constantly when the OJ-Air2 Master is energised.
- ✓ **"Auto"**. The circulation pump in the heat recovery battery runs when cooling or heating is required (valve setting > 0.1%).
- ✓ **"Outdoor temperature"**. The circulation pump in the heat recovery battery runs when there is a need for heat recovery – or when the outside temperature drops beneath the value set for the "Pump start" parameter. Start/stop has +/- 0.15°C hysteresis built in.

Pump exercising

- ✓ If the pump has not been in operation for the last 24 hours, it will be started for one minute regardless of heating demand to prevent pump seizure.

Pump start

The pump starts if outdoor temperature is lower than the value set. "Pump operation" must be set to "Outdoor temperature".

Recovery alarm

- ✓ Set a value for when a recovery alarm is to be activated.
- ✓ If a heat recovery sensor is fitted, the heat recovery system will be monitored monitors pump and valve faults. When the pump has received a start signal and the heat recovery signal is above 50%, the heat recovery sensor must record a temperature that is a set number of degrees above outdoor temperature. Otherwise, an alarm is activated after 10 minutes.

Outdoor temperature

- ✓ View actual outside temperature.

Stand-by heating

- ✓ When stopping the ventilation system, the mixing valve will open to ensure that the return flow from the fluid coupling battery does not get below the set value.

Frost protection

- ✓ Set value states return temperature from the fluid coupling battery, the valve has an 100% override. Override of the heating valve starts at the set value + "Frost P-band" (see inserted graphic)

Frost P-band

- ✓ Frost protection of the fluid coupling battery starts at the set value + set value in the parameter "Frost protection" (see inserted graphic)

Frost alarm

- ✓ The set value informs at which return temperature the systems stops and sounds the frost alarm.

Gainfactor, heat 1

- ✓ Set gain factor for fluid coupling battery

Valve setpoint

- ✓ Actual setpoint of the connected Direct Modbus valve

Test run, heating1 (only relevant with Direct Modbus actuators)

- ✓ Press "Start" to begin a sequence of tests of the connected Direct Modbus valve.

Alarm due to low efficiency

- ✓ Select whether an alarm is to be activated at low efficiency.

Efficiency correction factor

- ✓ Set correction factor for efficiency calculation.

Alarm level, efficiency

- ✓ Set alarm limit for low efficiency alarm.
- ✓ In order for the alarm to be activated, the system must be in "Operating" status, efficiency must be lower than the value set and the parameter "Alarm at low efficiency" must be set to "Yes".

Parameter	Value	Unit
Pump operation	Auto	
Pump operation	15.0	°C
Recovery temperature	8.0	°C
Outdoor temperature	0.0	°C
Standby heating	25.0	°C
Frost protection	5.0	°C
Frost P-band	5.0	°C
Frost alarm	2.0	°C
Gain factor, heat recovery	100	
Alarm at low efficiency	No	
Correction faktor, heat exchanger efficiency	0.0	%
Alarm level, efficiency	70	%
Motorvalve	0-10V	

Service settings

Setting components

Setting service parameters for Heat recovery: Counter-flow heat exchanger

Introduction:

The damper (or dampers) of the counter-flow heat exchanger are controlled by a modulating 0-10V signal from the OJ-Air2 system. The damper motor (or motors) of the exchanger/bypass damper must be capable of being controlled by a modulating 0-10V signal.

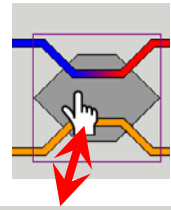

The counter-flow heat exchanger is protected against ice formation by recording the temperature of the exhaust air after the extract air has passed the heat exchanger.

Counter-flow heat exchanger		
Parameter	Value	Unit
Ice protection	5.0	°C
Ice protection P-band	5.0	°C
Gain factor, heat recovery	100	
Damper setpoint	0.0	%
Test run	Not activ	<input type="button" value="Start"/>
Alarm at low efficiency	No	<input type="button" value="Start"/>
Correction faktor, heat exchanger efficiency	0.0	%
Alarm level, efficiency	70	%

Ice protection

- ✓ At temperatures below the value set plus P-band, the bypass damper will be opened in a modulated fashion to 100% open. Fresh air thus bypasses the counter-flow heat exchanger while the air extracted from the room is passed through the exchanger. Because of the relatively high room temperature, this function will thaw the ice deposited on the counter-flow heat exchanger.

Gain factor, counter-flow heat exchanger

- ✓ Set gain factor for counter-flow heat exchanger

Damper counter-flow heat exchanger (only relevant with Direct Modbus actuators)

- ✓ Expected damper position.

Test run, bypass damper (only relevant with Direct Modbus actuators)

- ✓ Press "Start" to begin a sequence of tests of the connected Direct Modbus damper.

Alarm due to low efficiency

- ✓ Select whether an alarm is to be activated at low efficiency.

Efficiency correction factor

- ✓ Set correction factor for efficiency calculation.

Alarm level, efficiency

- ✓ Set alarm limit for low efficiency alarm.
- ✓ In order for the alarm to be activated, the system must be in "Operating" status, efficiency must be lower than the value set and the parameter "Alarm at low efficiency" must be set to "Yes".
- ✓

Service settings

Setting components

Setting service parameters for modulated recirculation

In general

The OJ-Air2 can control the fresh air, extract and recirculation damper for modulating recirculation-heat recovery via one common analogue output (0-10 V) (see figure 26.1) or via 2 analogue outputs (see figure 26.2).

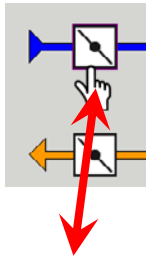

Outputs

- Analogue output "Extract and inlet damper" (0-10V)
- Analogue output "Recirculation damper" (0-10V)

Inlet damper

0-10V adjusting factor

- ✓ Adjusting factor for calibration of nonlinear damper

0-10V displacement

- ✓ Control area of damper motor.
Set to 2.0 if the damper motor is controlled in the voltage area 2-10 V.

Inlet damper		
Parameter	Value	Unit
Correktion	<input type="text" value="1.0"/>	
Offset	<input type="text" value="0.0"/>	%
Gain factor damper	<input type="text" value="100"/>	
Damper setpoint	<input type="text" value="0.0"/>	%
Test run	Not activ	<input type="button" value="Start"/>
<input type="button" value="Save"/>		

Gain factor, inlet damper

Set gain factor for inlet damper

Damper setpoint (only relevant with Direct Modbus actuators)

Expected damper position.

Test run, inlet damper (only relevant with Direct Modbus actuators)

Press "Start" to begin a sequence of tests of the connected Direct Modbus damper.

Exhaust damper

Gain factor, inlet damper

- ✓ Set gain factor for inlet damper

Damper setpoint (only relevant with Direct Modbus actuators)

- ✓ Expected damper position.

Test run, inlet damper (only relevant with Direct Modbus actuators)

- ✓ Press "Start" to begin a sequence of tests of the connected Direct Modbus damper.

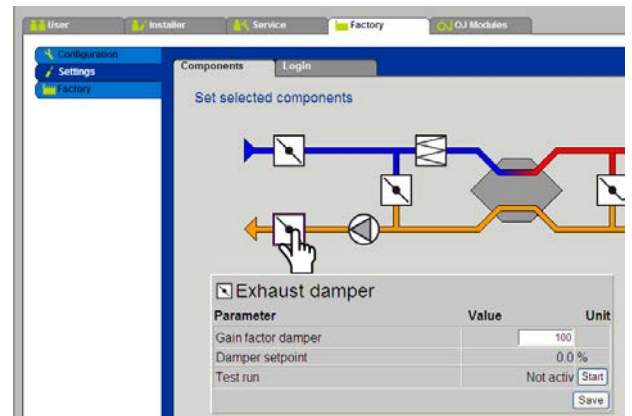

Service settings

Setting components

Recirculation damper

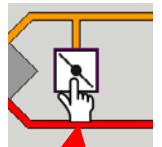

Recirculation damper		
Parameter	Value	Unit
I-time temperature	<input type="text" value="700"/>	sec
Correktion	<input type="text" value="1.0"/>	
Offset	<input type="text" value="0.0"/>	%
Gain factor damper	<input type="text" value="100"/>	
Damper setpoint	<input type="text" value="100.0"/>	%
Test run	Not activ	<input type="button" value="Start"/>
<input type="button" value="Save"/>		

I-time temperature

- √ I-time for recirculation damper in temperature regulation.

Correction

- √ Correction factor for non-linear dampers

Offset

- √ Damper control area – if 2-10V dampers, set the offset at 20.0%

Gain factor, inlet damper

- √ Set gain factor for inlet damper

Damper setpoint (only relevant with Direct Modbus actuators)

- √ Expected damper position.

Test run, inlet damper (only relevant with Direct Modbus actuators)

- √ Press "Start" to begin a sequence of tests of the connected Direct Modbus damper.

Drying damper

In general

Activate "Drying damper" to prevent mould from gathering in a moist filter in the fresh air intake.

By stopping the ventilation system, the dampers against the outside will closed and the fan continues to run at the set time to dry out possible moisture in the fresh air filter. Drying-out therefore takes place with recirculated air.

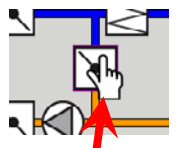

Drying damper		
Parameter	Value	Unit
Drying time	<input type="text" value="600"/>	sec
Damper setpoint	<input type="text" value="0.0"/>	%
Test run	Not activ	<input type="button" value="Start"/>
<input type="button" value="Save"/>		

Drying damper

- √ Drying time is the time the unit continues to operate with closed damper against the outside and open drying damper.

Damper setpoint (only relevant with Direct Modbus actuators)

- √ Expected damper position.

Test run, inlet damper (only relevant with Direct Modbus actuators)

- √ Press "Start" to begin a sequence of tests of the connected Direct Modbus damper.

Service settings

Fire alarm

Internal fire alarm

Monitoring of internal fire in the ventilation system.

This fire alarm uses inlet and exhaust sensors to monitor the temperature internally in the ventilation system.

If the temperature exceeds the values set for:

- ✓ Exhaust

or

- ✓ Inlet

– a "Fire alarm" (A-alarm) is activated, the system stops, dampers are closed and heating and cooling systems are shut down and monitored.

"Service -> Unit -> Fire alarm"

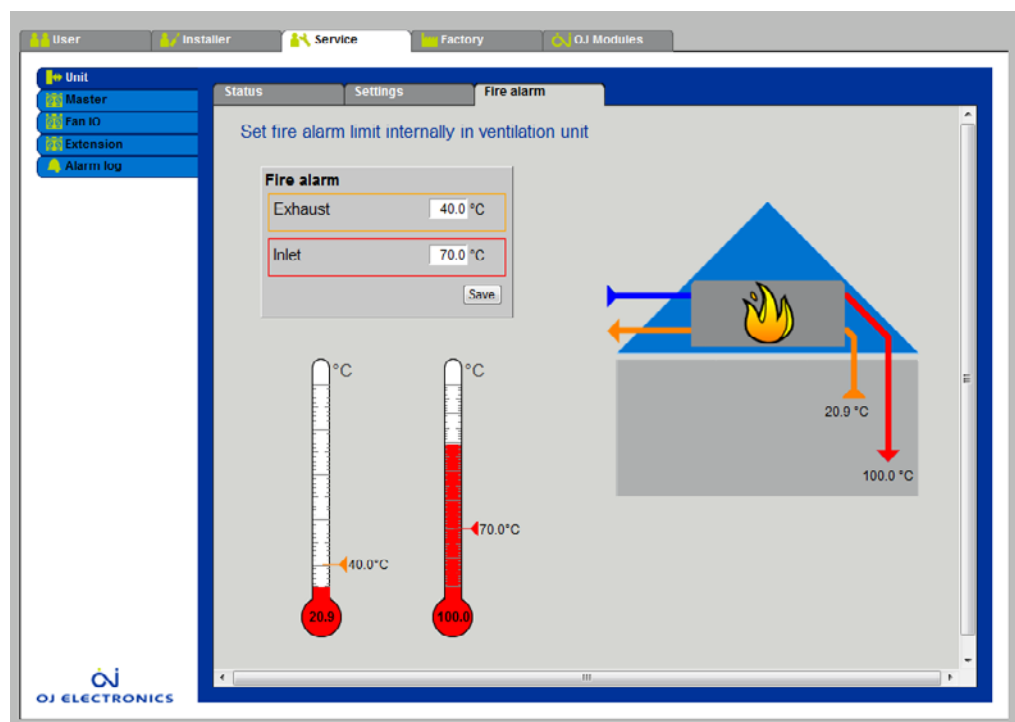

Service settings

Connectors overview

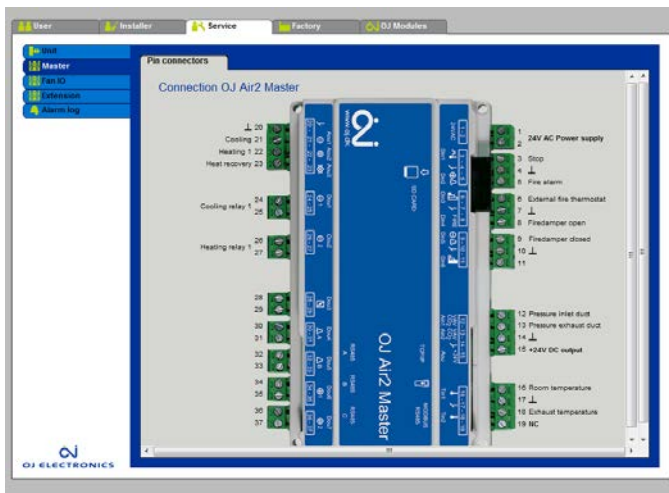

Overview display with updated texts for current configuration of terminal connections.

For documentation purposes:
Use "Print screen"

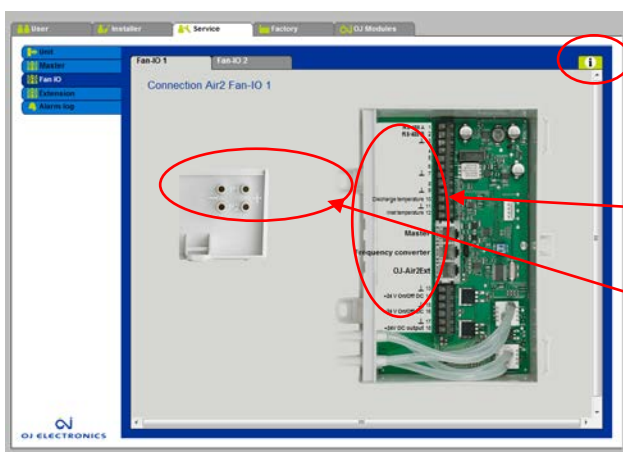
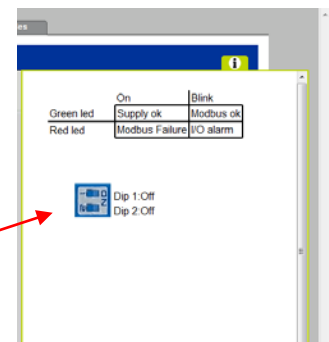

Overview display with updated texts for current configuration of:

- Terminal connections and terminal overview
- Connectors for pressure transmitters

Select: FanIO 1 or FanIO 2

For documentation purposes:
Use "Print screen"



Overview display with updated texts for current configuration of terminal connections.
Select EXT 1, EXT 2, EXT45 1, EXT45 2

For documentation purposes:
Use "Print screen"

Service settings

Setting service functions

Alarm & log

Alarms

- ✓ Shows a list of current alarms in the system
- ✓ Alarm number is shown
- ✓ Alarm text is shown
- ✓ Red text indicates A-alarms
- ✓ Blue text indicates B-alarms
- ✓ Click "Reset alarms" to acknowledge alarms
- ✓ When "Reset alarms" is activated, the alarm list is deleted and active alarms are then restored and displayed on the new alarm list.



Alarm log

- ✓ Shows a list of the last 16 alarms recorded by the system
- ✓ Alarm number is shown
- ✓ Alarm text is shown
- ✓ Click "Reset alarms" to acknowledge alarms

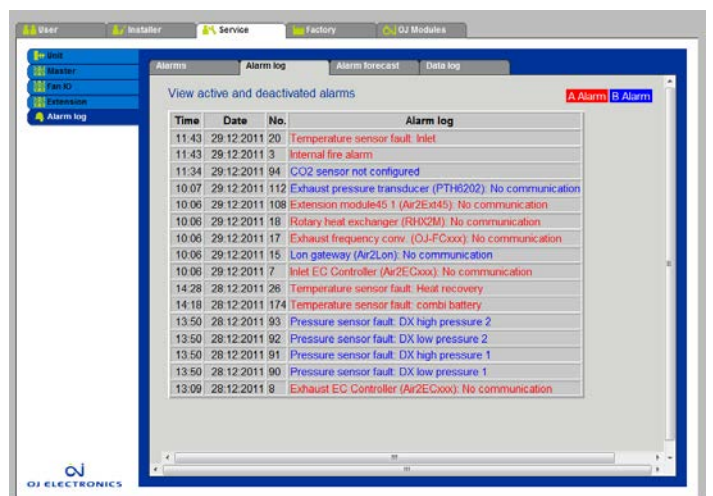

Alarm forecast

- ✓ Shows a list of alarms which have been detected by the system but have not yet been activated because of a time delay.
- ✓ For example, a filter alarm with a time delay of 20 minutes will be shown on this list when the pressure drop across the filter exceeds the alarm level set.
- ✓ If the pressure drop still exceeds the limit set after the 20 minutes have elapsed, the alarm will be activated, deleted from the "Alarm forecast" list and added to the "Alarms" list.



A list of A-alarms, B-alarms, alarm limits and alarm delays can be seen in section 11 of this folder.

Service settings

Setting service functions

Data log

System values are saved in a data log in the OJ-Air2 Master for one week, allowing data to be viewed for the previous week or previous 24-hour period.

Tick the required parameter to select what is to be shown in the various groups:

- ✓ Inlet (m³/h) or (Pa) with pressure control
- ✓ Extract (m³/h) or (Pa) with pressure control
- ✓ Temperature (°C)
- ✓ Flow (m³/h)
- ✓ Active alarms (number)
- ✓ Heating/Heat recovery/Cooling (%)

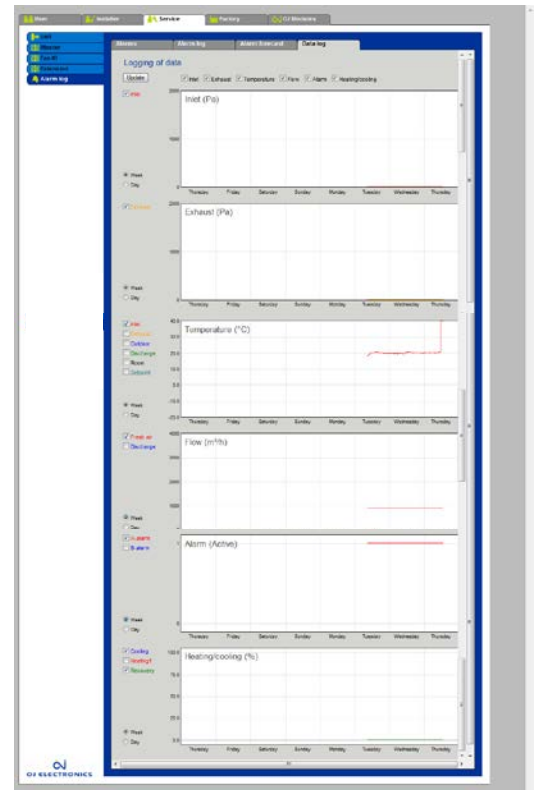

Within each group, select the values to be shown

Display data for previous week

Display data for previous day

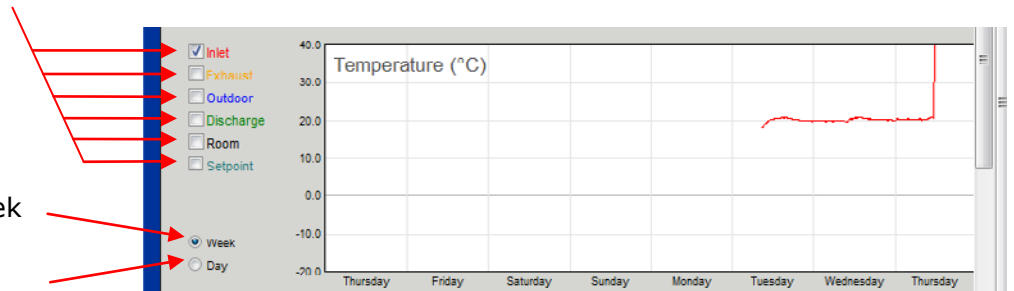

Click the display with the left-hand mouse button to enlarge the diagram.

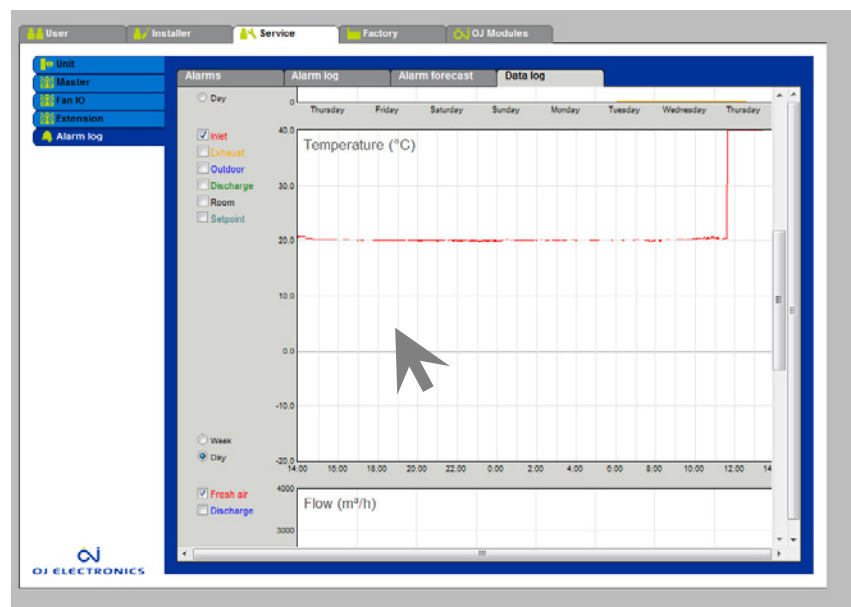

OJ-Air2 / 4-Zones included in the OJ-Air2Master

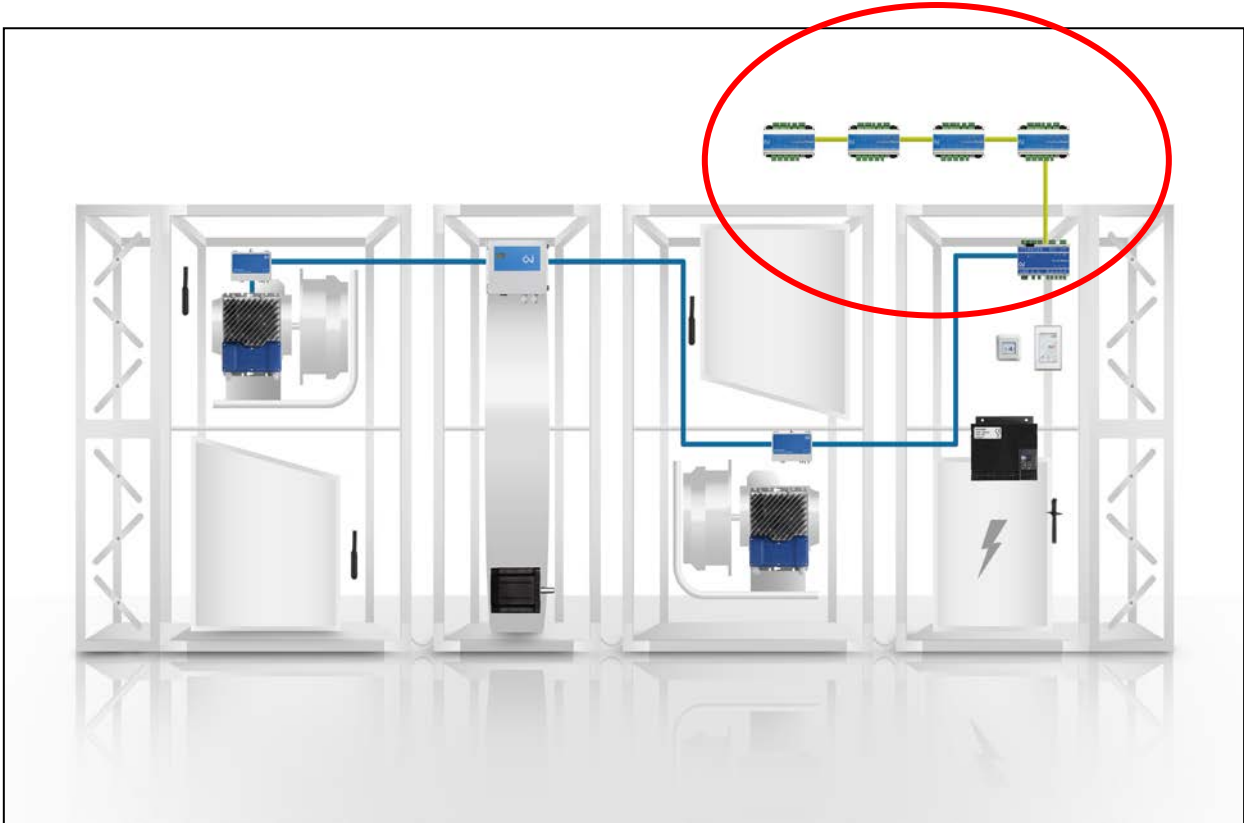

From SW. 4.19 the OJ-Air2 system includes zone control for up to 4 individual zones

- Control up to four VAV* zones directly from a single AHU, controlled from **OJ-Air2Master** system.
- Ideal for smaller-scale set-ups where different rooms have different indoor climate requirements – e.g. a car workshop, which have 4 rooms:

*VAV=Variable Air Volume
CAV=Constant Air Volume

- The workshop
- The office
- The warehouse
- The showroom

- Individual demand controlled indoor climate
- This 4 rooms do have fully individual setpoints and requirement for the temperature, humidity CO2 level and different time schedules.

About OJ Air2

The OJ Air2 range of AHU controls makes air handling units more efficient, more effective and easier to handle for everyone involved. The very extensive range includes everything required for full AHU control –master units, drives, touchscreen interfaces, sensors, pressure transmitters etc. – allowing systems designers to create millions of possible configurations. The individual elements do all share OJ hallmarks such as easy installation, much simpler cabling with QuickPlug™ Modbus technology and intuitive operation. Find more informations on www.ojelectronics.com

Electrical installation

Information for the electrical installation and connections in the zones and of the Zone Modules you find in the instruction (*booklet*) which follows together with the Zone Module.

3 different models

Zone Modules are produced and delivered in 3 different models depending on the communication platform to the actuators in the VAV zones:

Zone Module A = Analog 0-10V signals for the actuators

Zone Module M = Modbus communication for the actuators

Zone Module MP = MP-bus communication for the actuators

NOTE!

It is possible to make a mix of the 3 models and types within the same installation group.

RPT-20T = Modbus room panel;

Touch display with integrated room temperature sensor.

Manuals on this page can be downloaded from:

www.ojelectronics.com



Electrical installation

In the "Instructions" illustrated on previous page, common for the Zone Modules is, that in a standard **OJ Green Zone** system, they all are connected to an Green Zone Master. Different from the description in the "Instructions" on previous page, is that in this **4-Zone solution**, the Zone Modules are connected to the OJ-Air2Master.



In the **OJ-Air2/4-Zone system** the functionality which, in a traditional **OJ Green Zone** system is made in the **OJ-Green-Zone-Master**, is from SW 4.19, integrated in the **OJ-Air2Master**.

Meaning that the Modbus to the Zone Modules are still, like in an traditional **OJ Green Zone** system, connected together in daisy chain – but the first Zone Module are now connected to the OJ-Air2 Master **port "A"**.

The addressing of the Zone Modules is made automatic by the OJ-Air2 Master when power-up the system and addressing is always:

- **First Zone Module in the daisy chain, seen from the OJ-Air2Master: First Zone Module = Address 1; Next in the chain = Address 2; Next in the chain = Address 3; and so on.....**
- **The actual address of the Zone Module, is displayed on the 2 x 7-segment display.**

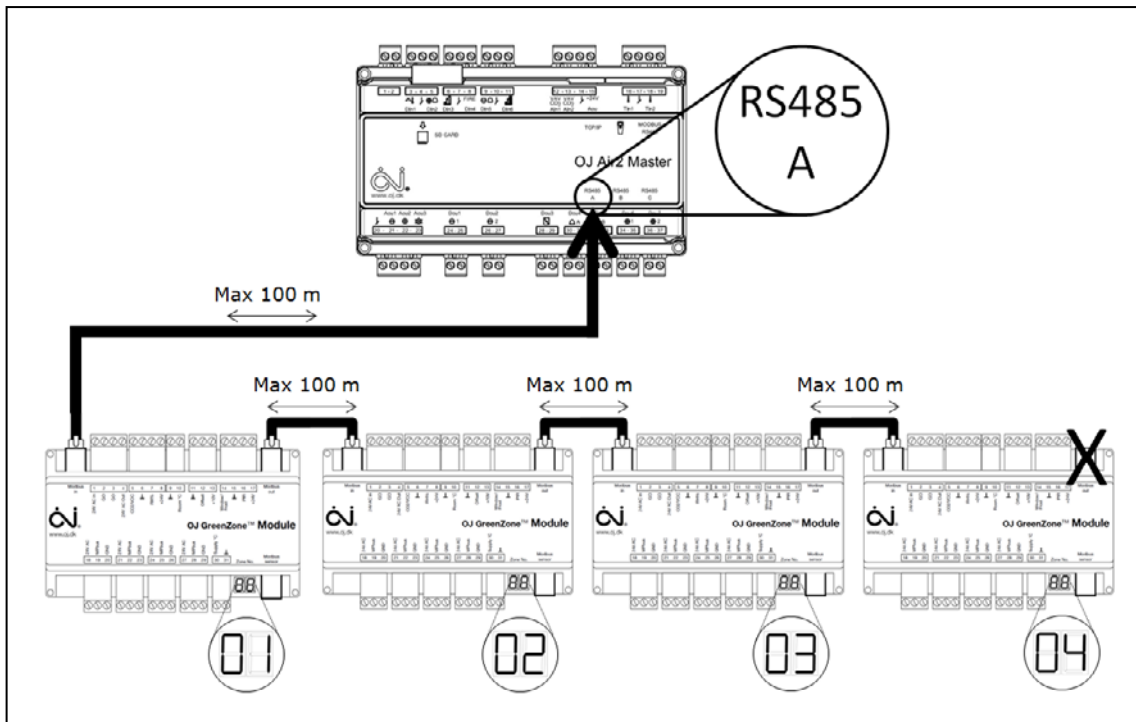

**Only daisy chain connection between Zone Modules allowed.
NOTE! NO star connections allowed.**

Electrical connection in the zones

All electrical connection in the individual Zones, like connecting:

- VAV damper actuators
- Cooling and heating valves
- Humidity sensor (HTH)
- VOC/CO2 sensor (VTH)
- Supply air and room temperature sensor (PT-1000)
- Room touch panel (RPT-20T)

- is installed according to the "Instruction" on previous page.

Display read outs

OJ Zone Module is equipped with a 2-digit display

The display indicates various things as shown in table below.

The display alternates (flashes) between the activated functions and readouts.

Sample:

If the Zone Module is configured as follows:

- Connected to OJ-Air2Master
- Allocated zone no. 3 by OJ-Air2Master
- Temperature control is activated
- VOC/CO2 sensor is detected and CO2 control is activated
- Humidity sensor (HTH-6202) is detected and humidity control is activated
- Limit sensor temp. is detected and duct temperature control (min./max.) is activated
- A combined temperature/humidity sensor (HTH-6202) is installed in the exhaust duct
- A RPT-20T is installed

The display will swap between this displaying's:

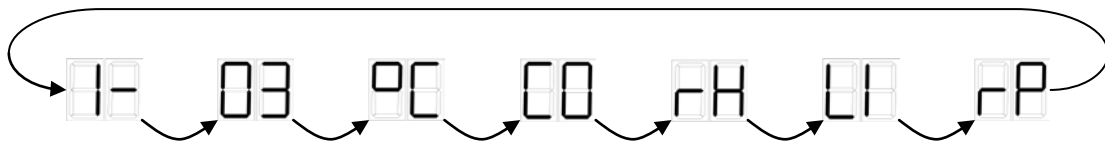

Display read outs	Comments
99	Zone section number (address) not yet allocated by the OJ-Air2Master
99	Zone number (address) not yet allocated by the OJ-Air2Master
1-	Actual OJ Zone Module is integrated in zone section 1 (Interval:1-1)
03	Shows the actual number (address) of the Zone Module (interval: 1-4)
9C	Temperature sensor connected correctly (inlet, exhaust or room sensor)
00	CO2 sensor connected correctly (exhaust or room sensor)
rH	Humidity sensor (HTH-XXXX) connected correctly (exhaust or room sensor)
rP	RPT-20T room touch panel installed and detected from the Zone Module
01	Limit (°C) sensor in the supply air VAV duct installed and detected from the Zone Module
SE	Short circuit detected in the sensor measuring loop
SU	Software update is ongoing – wait...

Installer settings

Autodetect

In general

All installer settings is made from the WEB pages on the OJ-Air2Master.

When a Zone Modules is connected

As soon as the OJ-Air2Master detects a Zone Module or more on the Modbus port "A", the Zone Module will automatic be configured on the Modbus and assigned an address.

The connected Zone Modules will automatic be selected under:

"Factory > Configuration > Electrical" and under **Modbus port "A"** parts –

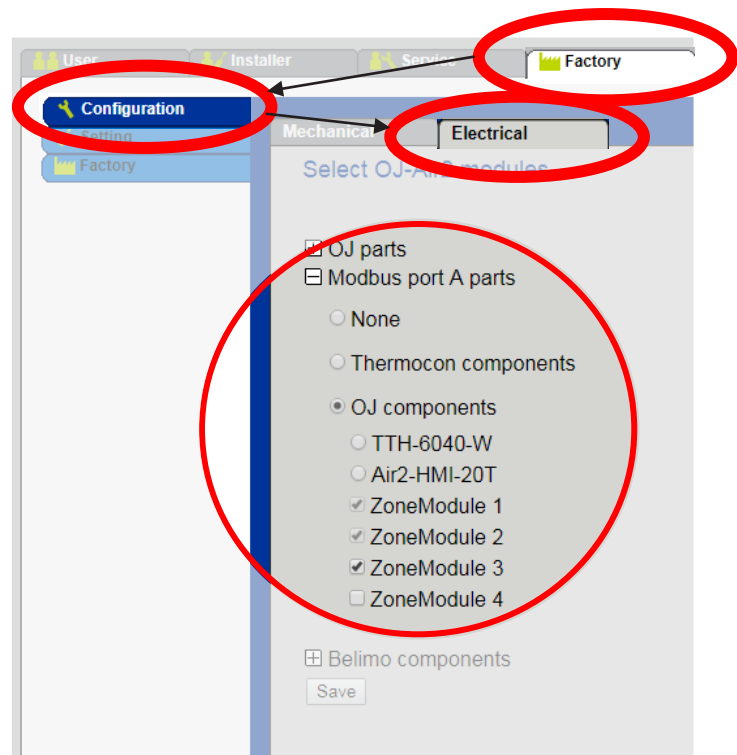

Installer settings

In general

Now we reach the setup programming of the connected zones.

Connected Zone Modules and components will automatically be detected from the Zone Module and selected under the setup window. Analog (0-10V) damper actuators must be selected manually.

When to use the "Reconfigure" button..?

Only if you add or remove a Zone Module to/from the system, you must reconfigure the system by pressing the "Reconfigure" button.

After pressing the "Reconfigure" button, the "Reconfigure" button will be greyed out (up to 1 minute) and you must wait until the "Reconfigure" button again is returned back to "normal".

During the reconfigure process, the page will display:

"No Zone Modules found" – see fig. > > > > > > > > > > > > >

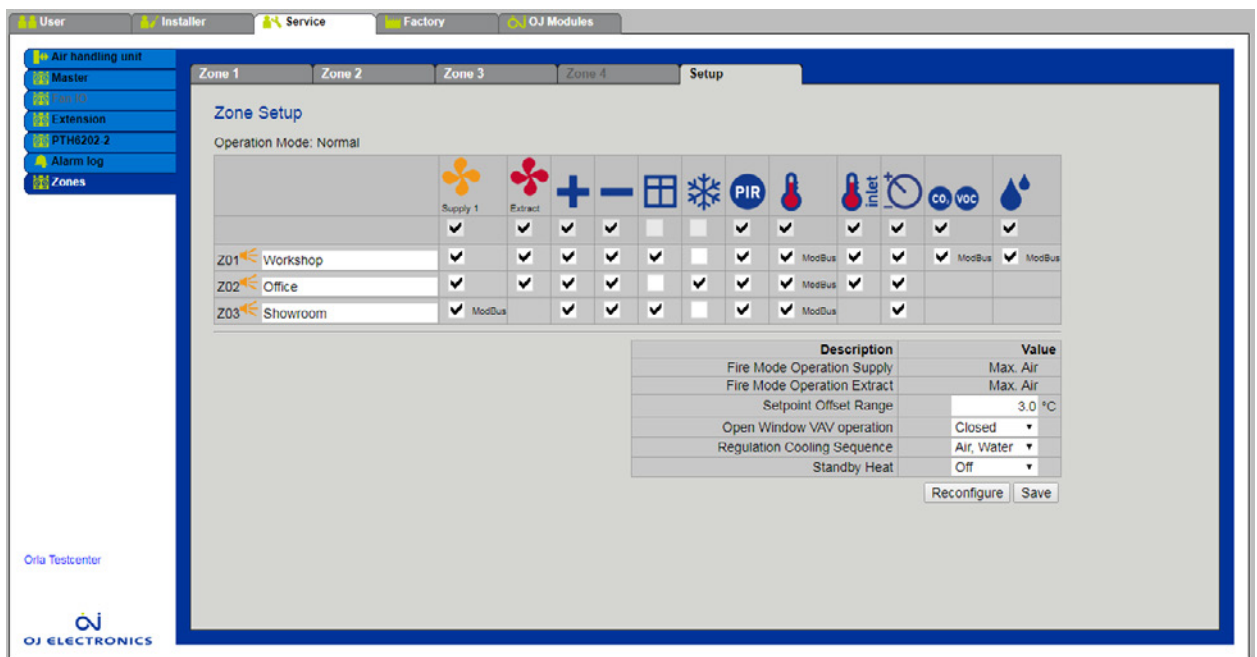
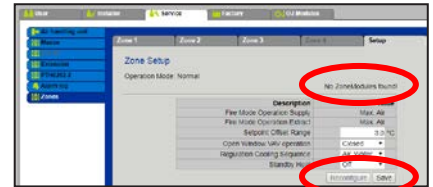

Give a name to the zone

- ✓ Here it is possible to give a saying name to the individual zones.
- ✓ The name is allowed to contain up to 19 characters (Numbers & letters)
- ✓ In this sample we connected 3 ZoneModules, that's why only 3 zones are displayed here in this sample.

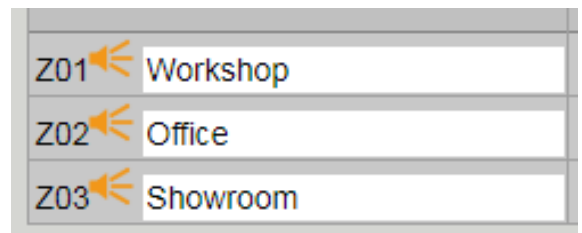

NOTE! Press "Save" after any change on this page, to save and download to the Zone Module..

The "Yellow Speaker" symbol

- ✓ The "Yellow Speaker" symbol between the "Z01" and the name is a tool for the service guy.
- ✓ Normal the ZoneModules are installed above the sealing and therefore it might be difficult to find the ZoneModules after installation and the sealing has been placed.
- ✓ By pressing the "Speaker" symbol, ZoneModules will give 3 times "Beep", "Beep", "Beep" – and the service guy will be able to find the installed Zone Module over the sealing, just listening and identify from where the "Beeps" sound comes.



...to be continued next page...

Installer settings

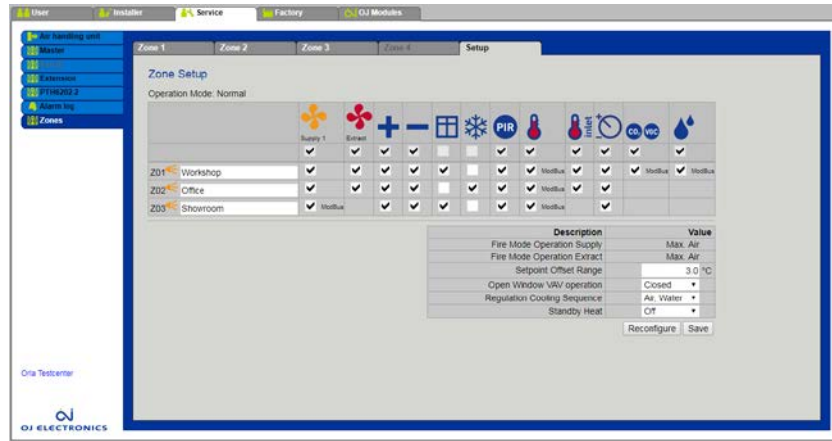

More info on check markings of the individual components in the zones: See next page..

NOTE! Press "Save" after any change Zone Setup on this page, to save and download to the Zone Module..

Setting the zone functionality

Fire Mode Operation Supply

In case of fire detection, it is possible here to select which position the supply air VAV damper must take.

- ✓ Closed: The VAV damper is closed
- ✓ Open: The VAV damper is open

Fire Mode Operation Extract

In case of fire detection, it is possible here to select which position the extract air VAV damper must take.

- ✓ Closed: The VAV damper is closed
- ✓ Open: The VAV damper is open

Setpoint offset range

If a potentiometer offset is used in the room, it is possible to set the maximum offset range

- ✓ 3°C: The offset range is +/- 3°C
- ✓ 5°C: The offset range is +/- 5°C

Open Window VAV operation

If a window contact is used, it is possible to select what position the VAV must take when the window is opened

- ✓ Normal: VAV damper continues auto control mode
- ✓ Closed: VAV dampers are closed if a window is opened

Regulation Cooling Sequence

Select the sequence of the cooling mode

- ✓ Air, Water: By cooling demand: First open the VAV damper and then the cooling valve
- ✓ Water, Air: By cooling demand: First open the cooling valve and then the VAV damper

Description	Value
Fire Mode Operation Supply	Max. Air
Fire Mode Operation Extract	Max. Air
Setpoint Offset Range	3.0 °C
Open Window VAV operation	Closed
Regulation Cooling Sequence	Air, Water
Standby Heat	Off

Reconfigure Save

Standby Heat













Select the mode of the standby heating when the AHU is stopped

- ✓ **Off**
 - If the heating source is via air flow in the VAV system
 - Heating is off and can be overruled by heating coil frost protection input
- ✓ **Frost protection**
 - If the room heat source is radiator or floor heating
 - Room temperature control loop will protect the room from freezing by using setpoint +5°C
- ✓ **Setpoint**
 - If the room heat source is heat panel or floor heating
 - Room temperature control loop will continue according to setpoint in WEB or RPT-20T

Configuring the zones

NOTE!

The checkmark in first line, is a common checkmark so you can select all Zones using one checkmark.

 <p>Supply 1</p> <input checked="" type="checkbox"/> <input checked="" type="checkbox"/> <input checked="" type="checkbox"/> <input checked="" type="checkbox"/> ModBus	<p>Select "Supply" if an VAV damper is connected on to the actual zone. If a Modbus actuator is detected, "Modbus" will be displayed to indicate that this VAV actuator is a Modbus actuator. MP-Bus will be displayed if a MP-Bus actuator is detected. Only check mark will be displayed if this VAV actuator is a 0-10V actuator.</p>	 <input checked="" type="checkbox"/> <input checked="" type="checkbox"/> <input checked="" type="checkbox"/> <input checked="" type="checkbox"/>	<p>Select "PIR" if a PIR sensor is connected on to the actual zone. When the PIR sensor see movements, the zone will switch to Supply Min. Air Flow acc. to the setpoint under PIR:</p> <table border="1" data-bbox="963 427 1501 477"> <thead> <tr> <th>PIR</th> <th>Current</th> <th>Not Active</th> </tr> </thead> <tbody> <tr> <td></td> <td>Supply Min. Air Flow</td> <td>33 m3/h</td> </tr> </tbody> </table> <p>If no movements detected in more than 10 minutes, the zone will go into normal operation.</p>	PIR	Current	Not Active		Supply Min. Air Flow	33 m3/h
PIR	Current	Not Active							
	Supply Min. Air Flow	33 m3/h							
 <p>Extract</p> <input checked="" type="checkbox"/> <input checked="" type="checkbox"/> <input checked="" type="checkbox"/>	<p>Select "Extract" if an VAV damper is connected on to the actual zone. If a Modbus actuator is detected, "Modbus" will be displayed to indicate that this VAV actuator is a Modbus actuator. MP-Bus will be displayed if a MP-Bus actuator is detected. Only check mark will be displayed if this VAV actuator is a 0-10V actuator.</p>	 <input checked="" type="checkbox"/> <input checked="" type="checkbox"/> ModBus <input checked="" type="checkbox"/> ModBus <input checked="" type="checkbox"/> ModBus	<p>Select "Room sensor" if an room sensor is connected on to the actual zone. If RPT-20T is detected, "Modbus" will be displayed to indicate that this sensor is a Modbus sensor.</p>						
 <input checked="" type="checkbox"/> <input checked="" type="checkbox"/> <input checked="" type="checkbox"/> <input checked="" type="checkbox"/>	<p>Select "Heating coil" if an heating coil is installed in the actual zone. If a Modbus actuator is detected, "Modbus" will be displayed to indicate that this valve actuator is a Modbus actuator. MP-Bus will be displayed if a MP-Bus actuator is detected.</p>	 <input checked="" type="checkbox"/> <input checked="" type="checkbox"/> <input checked="" type="checkbox"/>	<p>Select "Inlet air sensor" if an supply air duct sensor is connected on to the actual zone. <i>("Inlet" is the same as "Supply")</i></p>						
 <input checked="" type="checkbox"/> <input checked="" type="checkbox"/> <input checked="" type="checkbox"/> <input checked="" type="checkbox"/>	<p>Select "Cooling coil" if an cooling coil is installed in the actual zone. If a Modbus actuator is detected, "Modbus" will be displayed to indicate that this valve actuator is a Modbus actuator. MP-Bus will be displayed if a MP-Bus actuator is detected.</p>	 <input checked="" type="checkbox"/> <input checked="" type="checkbox"/> <input checked="" type="checkbox"/> <input checked="" type="checkbox"/>	<p>Select "+/- offset temperature" if an offset temperature selector is connected on to the actual zone. This offset selector is a potentiometer, connected on the terminals</p>						
 <input checked="" type="checkbox"/> <input checked="" type="checkbox"/> <input checked="" type="checkbox"/> <input checked="" type="checkbox"/>	<p>Select "Window contact" if an window contact is installed in the actual zone. An open window = open contact, will put the actual zone in standby mode. It is possible to select either "Window" function or "Frost" function.</p>	 <input checked="" type="checkbox"/> <input checked="" type="checkbox"/> ModBus	<p>Select "VOC/CO2" if an VOC/CO2 sensor is connected on to the actual zone. If a Modbus sensor like VTH-6202 is detected, "Modbus" will be displayed to indicate that this sensor is a Modbus sensor.</p>						
 <input type="checkbox"/> <input type="checkbox"/> <input type="checkbox"/> <input type="checkbox"/>	<p>Select "Frost thermostat" if an frost thermostat is installed on the water based heating coil, in the actual zone. An open contact, will put the actual zone in to frost protection mode. Closed contact = OK.. It is possible to select either "Window" function or "Frost" function.</p>	 <input checked="" type="checkbox"/> <input checked="" type="checkbox"/> ModBus	<p>Select "Humidity sensor" if an humidity sensor is connected on to the actual zone. If a Modbus sensor like HTH-6202 is detected, "Modbus" will be displayed to indicate that this sensor is a Modbus sensor.</p>						

NOTE! Press "Save" after any change on this page, to save and download to the Zone Module.

Settings in the zones

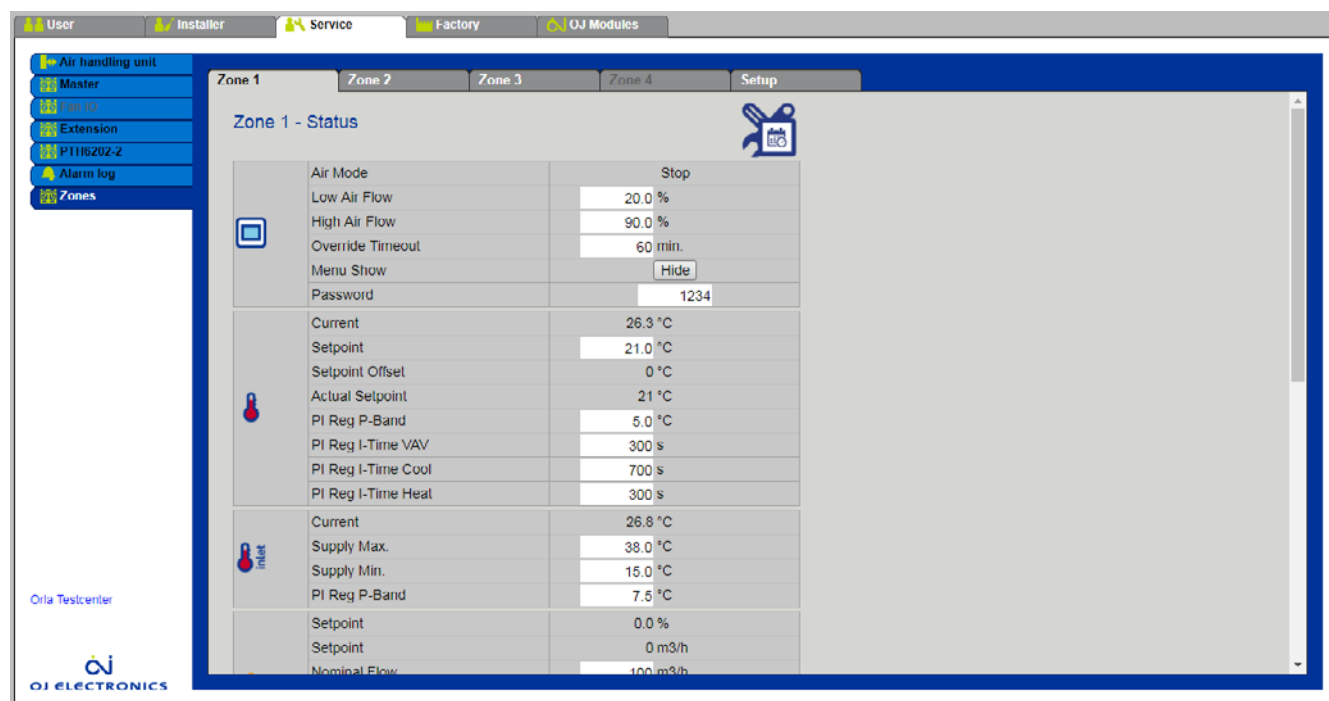

Auto configure function

What is displayed on the page depends on which actuators and sensor types are installed in the zone concerned. All sensors and actuators will automatically be displayed when electrical connected to the Zone Module. So the displayed window(s) **on the next pages**, depends on the connected sensors and actuators. By analog Zone Modules (Zone Module (A)) it is a smaller amount of values which will be displayed.

Setpoints for room temperature (°C), CO₂ (ppm) and humidity (RF%) can be changed and saved by clicking on the "Save" button at the bottom of the page. If the setpoints are exceeded, the PI controllers will increase the setpoint of the VAV dampers. P and I are factory set and need not normally be changed. If faster control is required, P-band and I-time can be reduced. If the VAV damper setpoint is unstable, increase P-band and I-time.

OJ-RPT20-T 2" touch panel (optional)

If an OJ-RPT20-T is connected to a zone, a few additional parameters will be visible in the zone setup, see next page.

Low/High Air Flow

If low or high air flow is selected on the touch panel, the air flow will be controlled according to this value.

This air flow will be maintained until the override timeout has elapsed.

Override Timeout

If low or high air flow is activated, the system will return to Auto mode after the override timeout has elapsed. Setting range: min. 10 minutes, max. 90 minutes.

Menu Show

Hides/shows the Menu button on the RPT20-T touch panel.

Password

Most parameters in the Setup menu of the RPT20-T touch panel are password protected. The password must consist of 4 digits, each between 1 and 6.



Further informations for the RPT-20T

For further information of the RPT-20T, look in the instructions which was delivered in the same packaging together with the RPT-20T. Find more informations on www.ojelectronics.com

Settings in the zones

• RPT-20T Room panel



- Air mode:** Actual status Auto, Low, High, Stop
- Low Air Flow:** Actual Air Flow
- High Air Flow:** Actual Air Flow
- Override Timeout:** When changing status from the RPT-20T, this status will be kept activated in selected time.
- Menu Show:** Show menu in the RPT-20T
- Password:** Set and change password RPT-20T

• Room settings (Temperature)



- **Current:** Actual room temperature
- **Setpoint:** Setpoint set from WEB or RPT-20T
- **Setpoint Offset:** Actual setpoint offset (+/- °C)
- **Actual Setpoint:** Actual setpoint (°C)
- **PI Reg P-Band:** Temperature P-Band
- **PI Reg I-Time VAV:** I-Time VAV
- **PI Reg I-Time Cool:** I-Time Cooling mode
- **PI Reg I-Time Heat:** I-Time Heating mode

• Supply air settings (Temperature)



- **Current:** Actual supply air temperature
- **Supply Max.:** Supply max. inlet temp.
- **Supply Min.:** Supply min. inlet temp.
- **PI Reg P-band**

• VOC/CO2 (ppm)



- **Current:** Actual room air VOC/CO2
- **Setpoint:** Setpoint set from WEB
- **PI Reg P-Band:** VOC/CO2 P-Band
- **PI Reg I-Time:** I-Time VOC/CO2

• Humidity (%rh)



- **Current:** Actual room air humidity
- **Setpoint:** Setpoint set from WEB
- **PI Reg P-Band:** Humidity P-Band
- **PI Reg I-Time:** I-Time Humidity

Air Mode	Auto
Low Air Flow	20.0 %
High Air Flow	90.0 %
Override Timeout	60 min.
Menu Show	Hide
Password	1234
Current	26.1 °C
Setpoint	21.0 °C
Setpoint Offset	0.0 °C
Actual Setpoint	21.0 °C
PI Reg P-Band	7.0 °C
PI Reg I-Time VAV	50 s
PI Reg I-Time Cool	700 s
PI Reg I-Time Heat	300 s
Current	26.8 °C
Supply Max.	38.0 °C
Supply Min.	15.0 °C
PI Reg P-Band	7.5 °C
Current	450 ppm
Setpoint	800 ppm
PI Reg P-Band	750 ppm
PI Reg I-Time	1250 s
Current	34.9 % RH
Setpoint	70.0 % RH
PI Reg P-Band	7.5 % RH
PI Reg I-Time	1250 s

• **Supply air settings (Flow)**



- **Setpoint:** Actual setpoint in %
- **Setpoint:** Actual setpoint in m3/h
- **Current position:** Actuator pos. in % open
- **Current position:** Actuator pos. in ° angle
- **Current flow:** Actual flow in % of max.
- **Current flow:** Actual flow in m3/h
- **Nominal flow:** Read out from the actuator
- **Min. Air flow:** Setpoint min. air flow
- **Max. Air flow:** Setpoint max. air flow
- **Override:** Setpoint override position (&Enable)
- **Testrun:** Press "Start" to test the actuator
- **Adaption:** Press "Start" to run adaption
- **Serial number:** Read out serial number

Setpoint	100.0 %	
Setpoint	100 m3/h	
Current Position	100.0 %	
Current Position	80 °	
Current Flow	0.0 %	
Current Flow	0 m3/h	
Nominal Flow	100 m3/h	
Min. Air Flow	70 m3/h	
Max. Air Flow	100 m3/h	
Override	0.0 % <input type="checkbox"/> Enable	
Testrun	<input type="button" value="Start"/>	
Adaption	<input type="button" value="Start"/>	
-- more --		
Setpoint	100.0 %	
Setpoint	100 m3/h	
Current Position	100.0 %	
Current Position	80 °	
Current Flow	0.0 %	
Current Flow	0 m3/h	
Nominal Flow	100 m3/h	
Min. Air Flow	70 m3/h	
Max. Air Flow	100 m3/h	
Override	0.0 % <input type="checkbox"/> Enable	
Testrun	<input type="button" value="Start"/>	
Adaption	<input type="button" value="Start"/>	
-- more --		
PIR	Current	Not Active
	Supply Min. Air Flow	0 m3/h
	Current	Not Active
	Current	Closed

• **Extract air settings (Flow)**

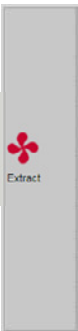

- **Setpoint:** Actual setpoint in %
- **Setpoint:** Actual setpoint in m3/h
- **Current position:** Actuator pos. in % open
- **Current position:** Actuator pos. in ° angle
- **Current flow:** Actual flow in % of max.
- **Current flow:** Actual flow in m3/h
- **Nominal flow:** Read out from the actuator
- **Min. Air flow:** Setpoint min. air flow
- **Max. Air flow:** Setpoint max. air flow
- **Override:** Setpoint override position (&Enable)
- **Testrun:** Press "Start" to test the actuator
- **Adaption:** Press "Start" to run adaption
- **Serial number:** Read out serial number

• **PIR (Movement detector)**



- **Current:** Active / Not active – 10 min efterløb..!!!!
- **Supply Min. Air Flow:** Setpoint min. flow
NOTE! When the zone is in "Auto" and the PIR detects activity in the room, the volume will switch to the setpoint "**Min. Air Flow**".
When the PIR detects no more movement in the room, there is an after run time of **10 minutes** and the room will go back to "Auto".

• **Frost** (The digital input: "Frost/Window", can be used as either "Frost" or "Window")



- **Current:** Actual status of the frost protection

• **Window** (The digital input: "Frost/Window", can be used as either "Frost" or "Window")



- **Current:** Actual status of the Window (Open/Closed)

....continued from previous page....

• Heating coil



- **Setpoint:** Calculated position open (%)
- **Current position:** Act. position open (%)
- **Current position:** Act. position open (°)
- **Override:** Setpoint override position (&Enable)
- **Testrun:** Press "Start" to test the actuator
- **Adaption:** Press "Start" to run adaption
- **Serial number:** Read out serial number

• Cooling coil



- **Setpoint:** Calculated position open (%)
- **Current position:** Act. position open (%)
- **Current position:** Act. position open (°)
- **Override:** Setpoint override position (&Enable)
- **Testrun:** Press "Start" to test the actuator
- **Adaption:** Press "Start" to run adaption
- **Serial number:** Read out serial number

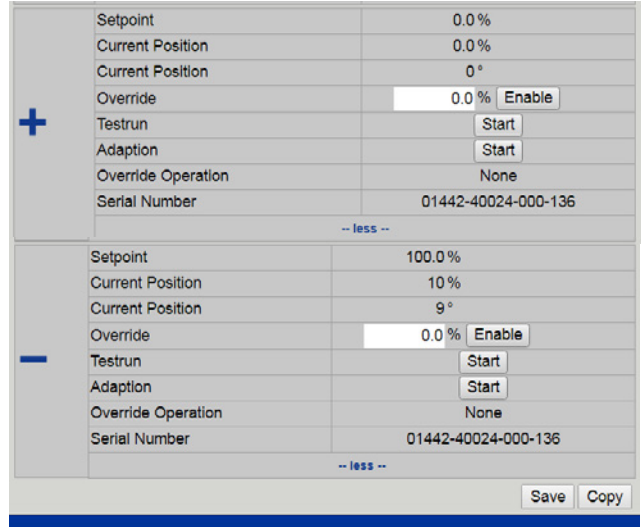

Press "Save" when finished selections and settings.

Copy function

- If several rooms are to have the same settings, it is possible to copy the settings from the completed zone to the others.
- Click on the "Copy" button at the bottom of the page (see figure).
- All settings for the zone concerned are copied to the entered zone number.
- In the example in figure, clicking "Copy" will overwrite the setpoints in Section 1 "Zone 1" and "Zone 2" with the values from Zone 3.

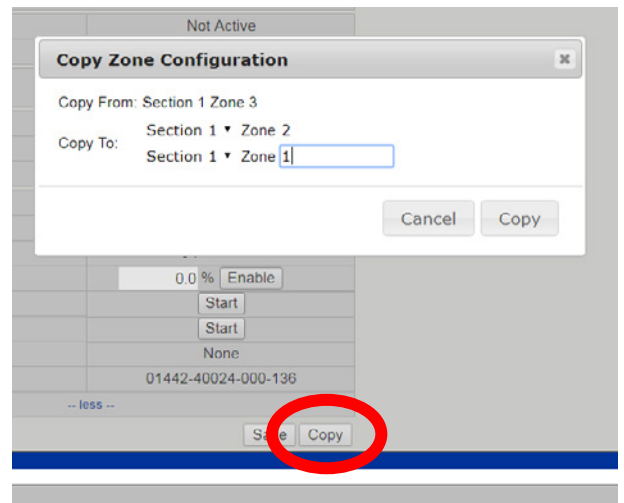

NOTE!

"Section 1" cannot be changed.
All Zones are in "Section 1"

Setting the time schedulers

In general

Now we reach the time to set the schedulers for operation mode in the individual zones. Each zone has his own scheduler time programme. The scheduler is divided into 4 slots where it is possible to select 4 different temperature settings, in 4 individual time slot during one day (24h).

There are 3 pre-programmed schedulers for each zone. It is possible to make timers using the same programme each and every day of the week, individual time schedulers each week day and same time schedulers for 5 working days of the week and another time scheduler for the weekends.

How to set the scheduler:

Go to the zone you want to see or change the time scheduler programme (Zone 1, 2, 3 & 4)

Press the "Tool & Scheduler" (see fig. 1) symbol in the right corner

Select if you want to make a scheduler programme that:

- Is the same for each and every day of the week (see fig. 2)
- Is the same for weekdays and for weekends (see fig. 3)
- Have individual scheduler programmes for each weekday (fig. 4)

Changing temperature setpoint in the time slot:

- Click the temp. digits
- Click the arrow (Up/Down)
- Press "Save"

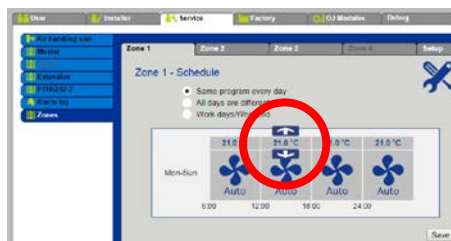

Changing scheduler time slot

- Click the time digits
- Click the arrow (Up/Down)
- Press "Save"

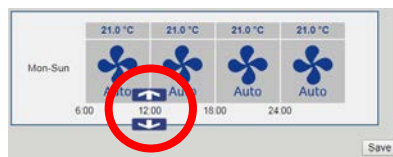

Change operation mode in the time slot

- Click the fan symbol
- Click more for changing status
- Press "Save"

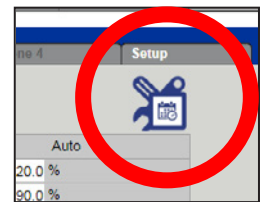
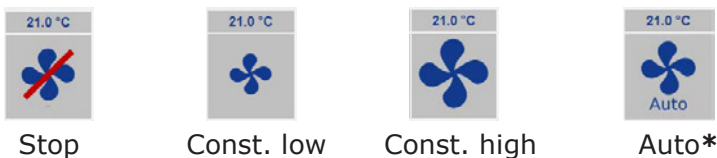
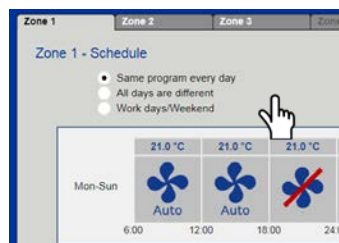

Fig. 1

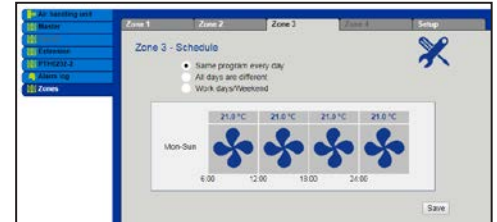

Fig. 2

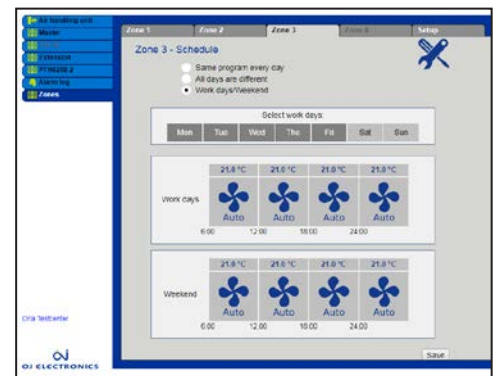

Fig. 3

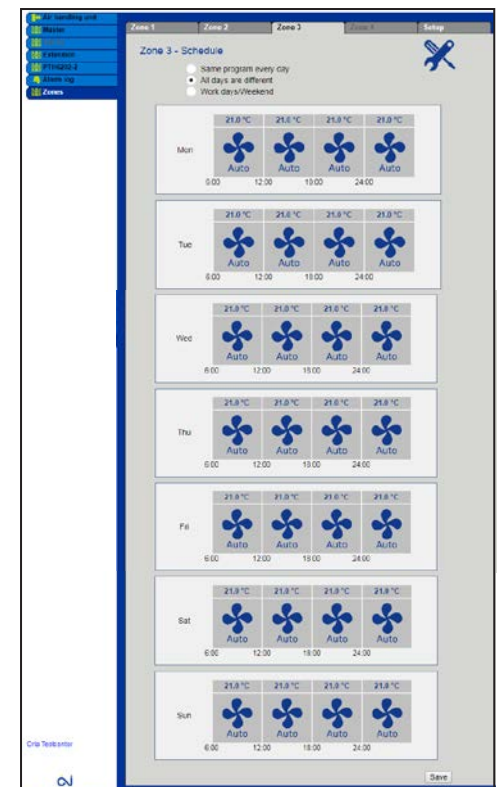

Fig. 4

***Auto** = VAV air volume will be controlled according to the setpoints (°C, %rh, CO2)

Configuring the OJ-Air2Master

Setting the fan control mode

In general

Every single Zone Module in the system, do control the air volume in the connected zone via their own VAV dampers. By cooling demand in the zone, the Zone Module will higher the air volume to the room.

If an humidity sensor and/or an VOC sensor is connected to the Zone Module, these also will higher the air volume to the room if there is a demand for dehumidify or too high VOC content.

If heating and/or cooling coils are installed in the VAV supply air duct and connected to the Zone Module, the heating/cooling valve will open by demand.

If only a room sensor like RPT-20T is installed, the VAV dampers will increase the air volume by cooling demand and decrease to minimum air volume by heating demand. The radiator heating system will then take care of the heating in the room.

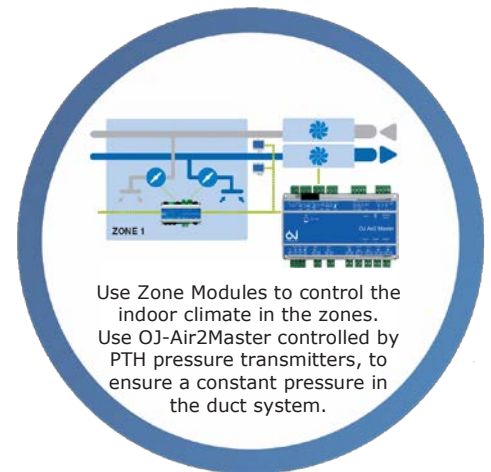

Prepare the air handling unit to handle the zone control system.

Set fan regulation.

To make the air handling (AHU) unit able always to deliver the correct air volume for the zones, you must select **“Constant pressure”** under “Installer > Operating > Setpoint” and select pressure setpoints that matches the demand for the zones and the zone duct system.

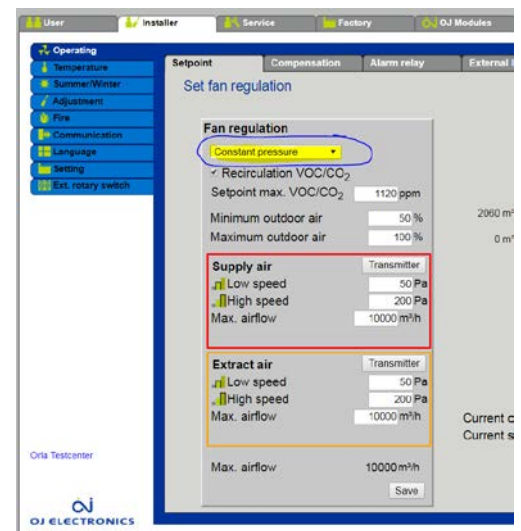

Set temperature regulation.

To make the AHU able always to deliver the correct temperature, you must under:

“Installer > Temperature > Regulation” select between:

- ✓ **“Constant supply air”**
- ✓ **“Constant extract air”**
- ✓ **“Constant room ”**

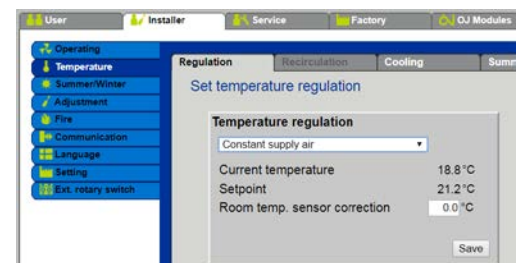

Summer night cooling (Free cooling)

If summer night cooling is selected and activated in the OJ-Air2 Master, all Zone VAV dampers will open in the time while summer night cooling is active.

Service

How to replace a defective Zone Module

If a Zone Module has gone broken and needs to be replaced, you must make a reconfiguration of the setup..

1. Power off the defective Zone Module
2. Build out the defective Zone Module
3. Build in the new Zone Module
4. Secure that all electrical connections are proper reassembled
5. Power up the new Zone Module
6. Press "Reconfigure"
7. Wait until all Zone Modules again are displayed correct on the "Setup page"

	Supply 1	Extract	+	-	Grid	Snowflake	PIR	Red Thermometer	Blue Thermometer	Inlet	Clock	CO ₂	VOC	Water Drop
Z01 Workshop	✓	✓	✓	✓	✓	✓	✓	✓	ModBus	✓	✓	✓	ModBus	ModBus
Z02 Office	✓	✓	✓	✓	✓	✓	✓	✓	ModBus	✓	✓	✓	✓	✓
Z03 Showroom	✓	ModBus	✓	✓	✓	✓	✓	✓	ModBus	✓	✓	✓	✓	✓

Description	Value
Fire Mode Operation Supply	Max. Air
Fire Mode Operation Extract	Max. Air
Setpoint Offset Range	3.0 °C
Open Window VAV operation	Closed
Regulation Cooling Sequence	Air, Water
Standby Heat	Setpoint

Reconfigure Save

Communication error

If a red cross is displayed instead of the checkmark, the communication to this component is broken.

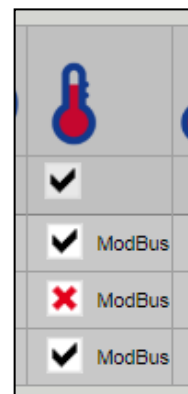

User interface (Read out)

Under the user level: "User > Alarm & Log > Zones" – all actual values will be displayed.

NOTE! It is not possible to change values from user level.

All user setting is done from the RPT-20T room touch display.

Zones - Status		Zone 1 Workshop	Zone 2 Office	Zone 3 Showroom
Air Mode		Auto	Auto	Auto
Low Air Flow		20.0 %	20.0 %	20.0 %
High Air Flow		90.0 %	90.0 %	90.0 %
Override Timeout		60 min.	60 min.	10 min.
Current		24.6 °C	25.8 °C	25.3 °C
Setpoint		21.0 °C	21.0 °C	20.5 °C
Actual Setpoint		21 °C	21.0 °C	20.5 °C
Current	Inlet	23.5 °C	23.4 °C	-
Current	CO ₂	638 ppm	-	-
Current		36.2 % RH	-	-
Setpoint		100.0 %	100.0 %	100.0 %
Setpoint	Supply1	100 m3/h	100 m3/h	100 m3/h
Setpoint		100.0 %	100.0 %	-
Setpoint	Extract	100 m3/h	100 m3/h	-
Current	PIR	Not Active	Not Active	Not Active
Current		Closed	-	Closed
Current		-	Not Active	-
Setpoint	+	0.0 %	0.0 %	0.0 %
Setpoint	-	100.0 %	100.0 %	100.0 %

If no **RPT-20T** room touch display installed, the user setting are to be done from the **Service level**

Zone 1 - Status		Auto
Air Mode		Auto
Low Air Flow		20.0 %
High Air Flow		90.0 %
Override Timeout		60 min.
Menu Show		Hide
Password		1234
Current		26.4 °C
Setpoint		21.0 °C
Actual Setpoint		21.0 °C
PI Reg P-Band		5.0 °C
PI Reg I-Time VAV		300 s
PI Reg I-Time Cool		700 s
PI Reg I-Time Heat		300 s
Current		24.7 °C
Setpoint		21.0 °C
Actual Setpoint		21.0 °C
Supply Max.		40.0 °C
Supply Min.		15.0 °C
PI Reg P-Band		7.5 °C
PI Reg I-Time VAV		300 s
PI Reg I-Time Cool		700 s

Alarms

All alarm from the Zone Modules will be displayed on the alarm tab under "User > Alarm & Log":

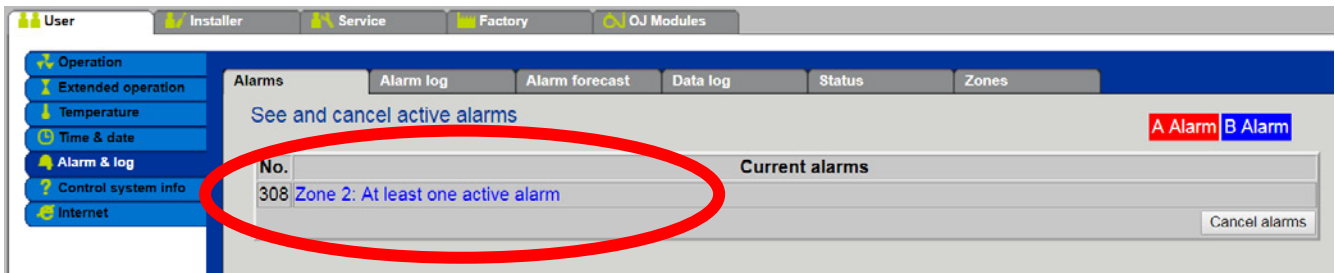

On the "Alarm tab", alarms from the Zones will be displayed as "Common alarms":

Sending out alarms to e-mail address

This alarm will be handled according to the standard handling procedure – meaning if the E-mail setup has been made, the alarm will be send to the e-mail address like setup under "Set email".

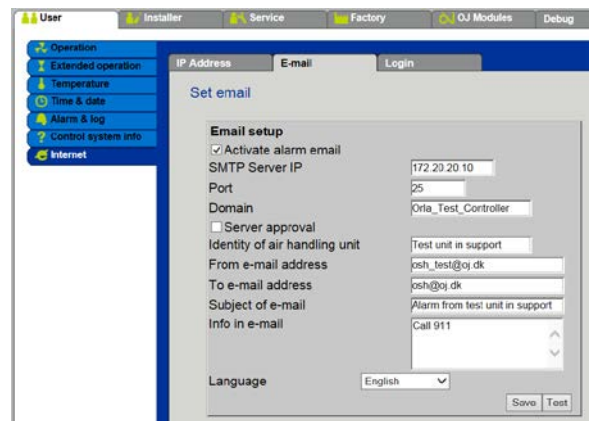

To find out which alarm is triggered in the individual Zones, all alarm from the Zone Modules will be displayed in the status window under User level:

User > Alarm & Log > Zones

Alarms are indicated with the alarm text written in red and the actual level is also now in red

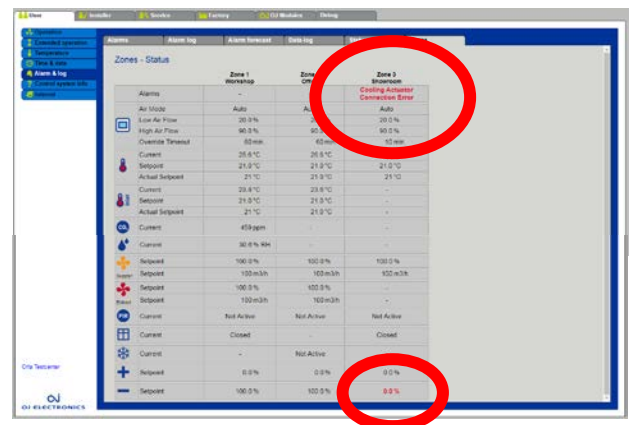

Software update

In general

SW update in the Zone Modules and RPT-20T are made from the OJ-Air2Master.

- Connect the power supply to the OJ Air2Master and power-on.
- Connect the OJ Air2-HMI-35T to the OJ-Air2Master in the plug marked:
- See if the HMI terminal powers up and light up in the display
- Place the SD-card in the card reader in the OJ Air2 Master
- The SD-card must be put into the controller like on this picture
- When the card is placed correctly in the card reader, use the OJ Air2-HMI-35T to activate the update process:

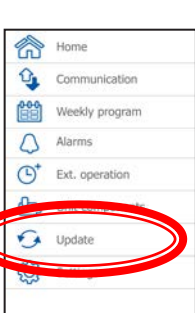

1. 

2. 

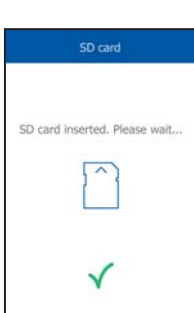
3. 

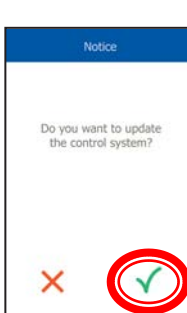
4. 

Give in PIN-code: 1111

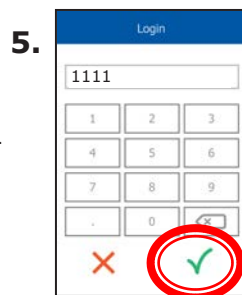

Update will now start...>

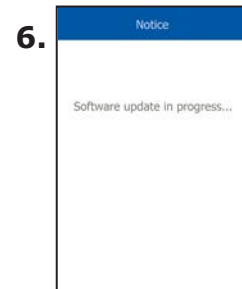

It is important to let the update process be completed before you press the touch display again, if not there is a risk to destroy the functionality of controller.

Wait until the update is completed and the display shows.....>>>



The display will automatic jump to the start screen when the Master is ready to operate..>>>



OJ-Air2 and Zone software is now updated and ready to use...

Alarmlist, OJ-Air2 SW 6.30					WEB Text		HTERM Text	
Alarm- number	Alarm- type	Alarm- delay sec.	Alarm- Limit	Unit stop	WEB text	Pop-up text	Alarm number	Alarm text
1	A	10	N/A		Fire alarm	Firealarm	Alarm 1	Fire alarm
2	A	10	N/A	X	External fire thermostat alarm	External Fire thermostat	Alarm 2	External fire thermostat alarm
3	A	10	N/A	X	Internal fire alarm	High supply/exhaust temperature in ventilation unit	Alarm 3	Internal fire alarm
4	B	10	N/A	X	External stop	Ekstern Stop	Alarm 4	External stop
7	A	10	N/A	X	Supply EC Controller (Air2ECxxx): No communication	Air2EC not connected to bus in FanIO port B, errors in the bus cable, buscable in the Air2EC must be in plug A	Alarm 7	Supply EC Controller (Air2ECxxx): No communication
8	A	10	N/A	X	Exhaust EC Controller (Air2ECxxx): No communication	Air2EC not connected to bus in FanIO port B, errors in the bus cable, buscable in the Air2EC must be in plug A	Alarm 8	Exhaust EC Controller (Air2ECxxx): No communication
9	B	1200	N/A	X	Filter monitor flow compensation not calibrated	Filter: pressure reference not measured. Activated after 20 minutes.	Alarm 9	Filter monitor flow compensation not calibrated
10	B	10	N/A	X	Handset (Air2Hterm): No communication	Handset not connected to bus	Alarm 10	Handset: No communication
11	A	10	N/A	X	FanIO 1 (Air2FanIO): No communication	FanIO not connected to bus in FanIO port A, wrong setting on the DIP switch in the FanIO	Alarm 11	FanIO 1: No communication
12	A	10	N/A	X	FanIO 2 (Air2FanIO): No communication	FanIO not connected to bus in FanIO port A, wrong setting on the DIP switch in the FanIO	Alarm 12	FanIO 2: No communication
13	A	10	N/A	X	Extension module 1 (Air2Ext): No communication	Air2Ext not connected to bus	Alarm 13	Extension module 1: No communication
14	A	10	N/A	X	Extension module 2 (Air2Ext): No communication	Air2Ext not connected to bus	Alarm 14	Extension module 2: No communication
15	B	10	N/A	X	Lon gateway (Air2Lon): No communication	Air2Lon not connected to bus	Alarm 15	Lon gateway: No communication
16	A	10	N/A	X	Supply frequency conv. (OJ-FCxxx): No communication	OJ-FC not connected to bus in FanIO port B	Alarm 16	Supply frequency conv.: No communication
17	A	10	N/A	X	Exhaust frequency conv. (OJ-FCxxx): No communication	OJ-FC not connected to bus in FanIO port B	Alarm 17	Exhaust frequency conv.: No communication
18	A	10	N/A	X	Rotary heat exchanger (RH2M): No communication	RHX2M not connected to bus	Alarm 18	Rotary heat exchanger: No communication
19	A	10	N/A	X	Pressure transducer (PTH): No communication	PTH not connected to bus; fault in bus cable; address button incorrectly set	Alarm 19	Pressure transducer (PTH): No communication
20	A	10	N/A	X	Temperature sensor fault: Supply air	Supply temp. sensor disconnected/short-circuited	Alarm 20	Temperature sensor fault: Supply air
21	A	10	N/A	X	Temperature sensor fault: Extract	Exhaust temp. sensor disconnected/short-circuited	Alarm 21	Temperature sensor fault: Extract
22	A	10	N/A	X	Temperature sensor fault: Room	Room temp. sensor disconnected/short-circuited	Alarm 22	Temperature sensor fault: Room
23	A	10	N/A	X	Temperature sensor fault: Exhaust	Discharge temp. sensor: G273	Alarm 23	Temperature sensor fault: Exhaust
24	A	10	N/A	X	Temperature sensor fault: Outdoor temperature	Outdoor temp. sensor disconnected/short-circuited	Alarm 24	Temperature sensor fault: Outdoor temperature
25	A	10	N/A	X	Temperature sensor fault: Water battery 1	Water battery temp. sensor disconnected/short-circuited	Alarm 25	Temperature sensor fault: Water battery
26	A	10	N/A	X	Temperature sensor fault: Heat recovery	Recovery temp. sensor disconnected/short-circuited	Alarm 26	Temperature sensor fault: Heat recovery
27	A	10	N/A	X	Pump alarm, heating 1	Water battery 1 fault	Alarm 27	Pump alarm; heating
28	A	10	N/A	X	Frost alarm, water battery 1	Low flow temperature	Alarm 28	Frost alarm, water battery
30	A	10	N/A	X	Supply frequency conv. (OJ-FCxxx): Low Supply voltage (Vio)	Low mains voltage	Alarm 30	Supply frequency conv.: Low Supply voltage (Vio)
31	A	10	N/A	X	Supply frequency conv. (OJ-FCxxx): High Supply voltage (Vhi)	High mains voltage	Alarm 31	Supply frequency conv.: High Supply voltage (Vhi)
32	A	10	N/A	X	Supply frequency conv. (OJ-FCxxx): High output current (Ihi)	Short-circuit in motor or cable	Alarm 32	Supply frequency conv.: High output current (Ihi)
33	A	10	N/A	X	Supply frequency conv. (OJ-FCxxx): High temperature (Thi)	High ambient temperature	Alarm 33	Supply frequency conv.: High temperature (Thi)
34	A	10	N/A	X	Supply frequency conv. (OJ-FCxxx): Lacking Supply phase	Mains voltage lacks a phase	Alarm 34	Supply frequency conv.: Lacking Supply phase
35	B	10	N/A	X	Supply frequency conv. (OJ-FCxxx): High internal ripple voltage	Mains voltage unstable	Alarm 35	Supply frequency conv.: High internal ripple voltage
37	A	30	N/A	X	Frequency converter alarm, supply	Frequency converter alarm, supply	Alarm 37	Frequency converter alarm, supply
38	B	600	N/A	X	Filter, supply	Pressure drop across supply filter too high	Alarm 38	Filter, supply
39	A	10	N/A	X	FanIO 1 (Air2FanIO): +24 V DC overloaded	+ 24 V DC from FanIO1 terminals 14,16,18 short-circuited	Alarm 39	FanIO 1: +24V DC overloaded
40	A	10	N/A	X	Exhaust frequency conv. (OJ-FCxxx): Low supply voltage (Vio)	Low mains voltage	Alarm 40	Exhaust frequency conv. Low supply voltage (Vio)
41	A	10	N/A	X	Exhaust frequency conv. (OJ-FCxxx): High supply voltage (Vhi)	High mains voltage	Alarm 41	Exhaust frequency conv.: High supply voltage (Vhi)
42	A	10	N/A	X	Exhaust frequency conv. (OJ-FCxxx): High output current (Ihi)	Short-circuit in motor or cable	Alarm 42	Exhaust frequency conv.: High output current (Ihi)
43	A	10	N/A	X	Exhaust frequency conv. (OJ-FCxxx): High temperature (Thi)	High ambient temperature	Alarm 43	Exhaust frequency conv.: High internal temperature
44	A	10	N/A	X	Exhaust frequency conv. (OJ-FCxxx): Lacking supply phase	Mains voltage lacks a phase	Alarm 44	Exhaust frequency conv.: Lacking supply phase

Alarmlist, OJ-Air2 SW 6.30					WEB Text		HTERM Text		
Alarm-number	Alarm-type	Alarm-delay sec.	Alarm-Limit	Auto reset	Unit stop	WEB text	Pop-up text	Alarm number	Alarm text
45	B	10	N/A			Exhaust frequency conv. (OJ-FCxxx): High internal ripple voltage	Mains voltage unstable	Alarm 45	Exhaust frequency conv.: High internal ripple voltage
47	A	30	N/A		X	Frequency converter alarm, exhaust	Frequency converter alarm, exhaust	Alarm 47	Frequency converter alarm exhaust
48	B	600	N/A			Filter exhaust	Pressure drop across exhaust filter too high	Alarm 48	Filter, exhaust
49	A	10	N/A		X	FanIO 2 (Air2/FanIO): +24 V DC overloaded	+ 24 V DC from FanIO1 terminals 14,16,18 short-circuited	Alarm 49	FanIO 2: +24V DC overloaded
50	B	10	N/A			Rotary heat exchanger (RHX2M): No rotation	No pulse from rotation monitor	Alarm 50	Rotary heat exchanger: No rotation
51	B	10	N/A			Rotary heat exchanger (RHX2M): Low supply voltage (Vio)	Low mains voltage	Alarm 51	Rotary heat exchanger: Low supply voltage (Vio)
52	B	10	N/A			Rotary heat exchanger (RHX2M): High supply voltage (Vhi)	High mains voltage	Alarm 52	Rotary heat exchanger: High supply voltage (Vhi)
53	B	10	N/A			Rotary heat exchanger (RHX2M): High output current (Ihi)	Short-circuit in motor or cable	Alarm 53	Rotary heat exchanger: High output current (Ihi)
54	B	10	N/A			Rotary heat exchanger (RHX2M): High internal temperature	High ambient temperature	Alarm 54	Rotary heat exchanger: High internal temperature
55	B	10	N/A			Rotary heat exchanger (RHX2M): Torque overload	Rotor resists movement, e.g. due to lacking alignment. Step motor incapable of turning rotor at correct rpm.	Alarm 55	Rotary heat exchanger: Torque overload
58	A	300	N/A		X	Frost alarm, heat exchanger	Discharge temperature below frost limit despite bypass damper being ordered to open fully (OV).	Alarm 58	Frost alarm, heat exchanger
59	A	600	N/A		X	No heat recovery, low temperature	Recovery temp. in fluid coupling recovery battery too low for more than 10 minutes	Alarm 59	No heat recovery, low temperature
60	A	600	SP-5°C		X	*=Special according to "Alarm 60" 1) If Heat1 and/or Heat2 is installed, the Alarm 60 will be released if the supply air temperature is >5°C below the setpoint. 2) If alone an pre-heater is installed and temperature control mode is selected to "Constant room or - extract", the "Alarm60" will be released if the supply air temperature is < +59r. 3) If alone an pre-heater is installed and temperature control mode is selected to "Constant supply air", the "Alarm60" will be released if the supply air temperature is >10.0r below setpoint.	Supply temperature too low for more than 10 minutes	Alarm 60	Low supply temperature
61	B	600	SP+5°C			High supply temperature	Supply temperature too high for more than 10 minutes	Alarm 61	High supply temperature
62	B	1200	SP-5°C			Low extract temperature	Extract temperature too low for more than 20 minutes	Alarm 62	Low extract temperature
63	B	1200	SP+5°C			High extract temperature	Extract temperature too high for more than 20 minutes	Alarm 63	High extract temperature
65	B	300	N/A		X	Heating1 cut out due to low air volume	Air volume through electric heating battery too low for more than 5 minutes.	Alarm 65	Heating cut out due to low air volume
66	B	300	N/A			Electric battery1: overheating alarm	Overheat thermostat in electric heating battery has cut out.	Alarm 66	Electric battery: overheating alarm
68	B	1200	N/A		X	Contact for electric heating battery1 stuck	Contact for electric heating battery stuck	Alarm 68	Contact for electric heating battery stuck
70	B	600	SP-10%		X	High VOC/CO2	VOC/CO2 level too high for more than 20 minutes	Alarm 70	High VOC/CO2
71	B	600	SP+10%		X	Low supply air volume	Supply air volume too low for more than 10 minutes	Alarm 71	Low supply air volume
72	B	600	SP-10%		X	High supply air volume	Supply air volume too high for more than 10 minutes	Alarm 72	High supply air volume
73	B	600	SP+10%		X	Low exhaust air volume	Exhaust air volume too low for more than 10 minutes.	Alarm 73	Low exhaust air volume
74	B	600	SP-10%		X	High exhaust air volume	Exhaust air volume too high for more than 10 minutes.	Alarm 74	High exhaust air volume
75	A	600	SP+10%		X	Low supply air pressure	Supply pressure too low for more than 10 minutes.	Alarm 75	Low supply air pressure
76	B	600	SP-10%		X	High supply air pressure	Supply pressure too high for more than 10 minutes.	Alarm 76	High supply air pressure
77	A	600	SP+10%		X	Low exhaust air pressure	Exhaust pressure too low for more than 10 minutes.	Alarm 77	Low exhaust air pressure
78	B	10	N/A			High exhaust air pressure	Exhaust pressure too high for more than 10 minutes.	Alarm 78	High exhaust air pressure
80	B	3	N/A			Cooling fault	Cooling fault	Alarm 80	Cooling fault
81	B	3	N/A			Low cooling pressure circuit 1	Cooling circuit 1: Pressure in evaporator too low. Insufficient coolant/leaks.	Alarm 81	Low cooling pressure circuit 1
82	B	3	N/A			High cooling pressure circuit 1	Cooling circuit 1: Pressure in condenser too high. Too much coolant. High temperature in condenser.	Alarm 82	High cooling pressure circuit 1
83	B	3	N/A			Cooling fault 1: Compressor 1 overheated circuit 1	Cooling fault 1	Alarm 83	Cooling fault 1: Compressor 1 overheated circuit 1
84	B	3	N/A			Cooling fault 2: Compressor 2 overheated circuit 1	Cooling fault 2	Alarm 84	Colling fault 2: Compressor 2 overheated circuit 1
85	B	3	N/A			Low cooling pressure circuit 2	Cooling circuit 2: Pressure in evaporator too low. Insufficient coolant/leaks.	Alarm 85	Low cooling pressure circuit 2
86	B	3	N/A			High cooling pressure circuit 2	Cooling circuit 2: Pressure in condenser too high. Too much coolant. High temperature in condenser.	Alarm 86	High cooling pressure circuit 2
87	B	3	N/A			Cooling fault 3: Compressor 1 overheated circuit 2	Cooling fault 3	Alarm 87	Colling fault 3: Compressor 1 overheated circuit 2
88	B	3	N/A			Cooling fault 4: Compressor 2 overheated circuit 2	Cooling fault 4	Alarm 88	Cooling fault 4: Compressor 2 overheated circuit 2

Alarmlist, OJ-Air2 SW 6.30				WEB Text		HTERM Text			
Alarm-number	Alarm-type	Alarm-delay sec.	Alarm-Limit	Unit reset	Unit stop	WEB text	Pop-up text	Alarm number	Alarm text
90	B	3	N/A			Pressure sensor fault: DX low pressure 1	DX low pressure 1	Alarm 90	Pressure sensor fault: DX low pressure 1
91	B	3	N/A			Pressure sensor fault: DX high pressure 1	DX high pressure 1	Alarm 91	Pressure sensor fault: DX high pressure 1
92	B	3	N/A			Pressure sensor fault: DX low pressure 2	DX low pressure 2	Alarm 92	Pressure sensor fault: DX low pressure 2
93	B	3	N/A			Pressure sensor fault: DX high pressure 2	DX high pressure 2	Alarm 93	Pressure sensor fault: DX high pressure 2
94	B	10	N/A	X		VOC/CO2 sensor not configured	VOC/CO2 sensor not configured	Alarm 94	VOC/CO2 sensor not configured
95	B	10	N/A	X		FanOpt. supply not configured	FanOpt. supply not configured	Alarm 95	FanOpt. supply not configured
96	B	10	N/A	X		FanOpt. exhaust not configured	FanOpt. exhaust not configured	Alarm 96	FanOpt. exhaust not configured
100	A	10	N/A	X	X	Pressure sensor 0 (PTH6202): No communication	Pressure sensor 0 (PTH6202): No communication	Alarm 100	Pressure sensor 0 (PTH6202): No communication
101	A	10	N/A	X	X	Pressure sensor 1 (PTH6202): No communication	Pressure sensor 1 (PTH6202): No communication	Alarm 101	Pressure sensor 1 (PTH6202): No communication
103	A	10	N/A	X	X	Pressure sensor 3 (PTH6202): No communication	Pressure sensor 3 (PTH6202): No communication	Alarm 103	Pressure sensor 3 (PTH6202): No communication
104	A	10	N/A	X	X	Pressure sensor 4 (PTH6202): No communication	Pressure sensor 4 (PTH6202): No communication	Alarm 104	Pressure sensor 4 (PTH6202): No communication
105	A	10	N/A	X	X	Pressure sensor 5 (PTH6202): No communication	Pressure sensor 5 (PTH6202): No communication	Alarm 105	Pressure sensor 5 (PTH6202): No communication
106	A	10	N/A	X	X	Pressure sensor 6 (PTH6202): No communication	Pressure sensor 6 (PTH6202): No communication	Alarm 106	Pressure sensor 6 (PTH6202): No communication
107	A	10	N/A	X	X	Pressure sensor 7 (PTH6202): No communication	Pressure sensor 7 (PTH6202): No communication	Alarm 107	Pressure sensor 7 (PTH6202): No communication
108	A	10	N/A	X	X	Extension module45 1 (Air2Ext45): No communication	Air2 Ext45 not connected to bus	Alarm 108	Extension module45 1 (Air2Ext45): No communication
109	A	10	N/A	X	X	Extension module45 2 (Air2Ext45): No communication	Air2 Ext45 not connected to bus	Alarm 109	Extension module45 2 (Air2Ext45): No communication
111	B	10	N/A	X		Supply pressure transducer (PTH6202): No communication	PTH6202 not connected to bus; fault in bus cable; address button incorrectly set	Alarm 111	Supply pressure sensor (PTH6202): No communication
112	B	10	N/A	X		Exhaust pressure transducer (PTH6202): No communication	PTH6202 not connected to bus; fault in bus cable; address button incorrectly set	Alarm 112	Exhaust pressure sensor (PTH6202): No communication
113	B	10	N/A	X		VOC/CO2 sensor fault	VOC/CO2 sensor disconnected/short-circuited; Sensor not configured for analog input.	Alarm 113	VOC/CO2 sensor fault: VOC/CO2 sensor disconnected/short-circuited
115	A	10	N/A	X	X	Supply EC Controller (Air2ECxxx): Alarm stop	Motor stopped due to alarm from EC Controller	Alarm 115	Supply EC Controller (Air2ECxxx): Alarm stop
116	A	10	N/A	X	X	Supply EC Controller (Air2ECxxx): Blocked rotor	Blocked EC motor	Alarm 116	Supply EC Controller (Air2ECxxx): Blocked rotor
117	B	2400	N/A	X		Supply EC Controller (Air2ECxxx): Current limit active	Rampup time to short, Motor overloaded, Wrong motor type	Alarm 117	Supply EC Controller (Air2ECxxx): Current limit active
118	B	10	N/A			Supply EC Controller (Air2ECxxx): Low Supply voltage (Vio)	Low mains voltage	Alarm 118	Supply EC Controller (Air2ECxxx): Low Supply voltage (Vio)
119	B	10	N/A			Supply EC Controller (Air2ECxxx): High Supply voltage (Vhi)	High mains voltage	Alarm 119	Supply EC Controller (Air2ECxxx): High Supply voltage (Vhi)
120	B	10	N/A			Supply EC Controller (Air2ECxxx): High temperature (Thi)	High ambient temperature, Overload EC Controller	Alarm 120	Supply EC Controller (Air2ECxxx): High temperature (Thi)
121	B	10	N/A			Supply EC Controller (Air2ECxxx): High internal ripple voltage	Mains voltage unstable	Alarm 121	Supply EC Controller (Air2ECxxx): High internal ripple voltage
122	A	10	N/A	X		Exhaust EC Controller (Air2ECxxx): Alarm stop	Motor stopped due to alarm from EC Controller	Alarm 122	Exhaust EC Controller (Air2ECxxx): Alarm stop
123	A	10	N/A	X		Exhaust EC Controller (Air2ECxxx): Blocked rotor	Blocked EC motor	Alarm 123	Exhaust EC Controller (Air2ECxxx): Blocked rotor
124	B	2400	N/A	X		Exhaust EC Controller (Air2ECxxx): Current limit active	Rampup time to short, Motor overloaded, Wrong motor type	Alarm 124	Exhaust EC Controller (Air2ECxxx): Current limit active
125	B	10	N/A			Exhaust EC Controller (Air2ECxxx): Low supply voltage (Vio)	Low mains voltage	Alarm 125	Exhaust EC Controller (Air2ECxxx): Low supply voltage (Vio)
126	B	10	N/A			Exhaust EC Controller (Air2ECxxx): High supply voltage (Vhi)	High mains voltage	Alarm 126	Exhaust EC Controller (Air2ECxxx): High supply voltage (Vhi)
127	B	10	N/A			Exhaust EC Controller (Air2ECxxx): High temperature (Thi)	High ambient temperature, Overload EC Controller	Alarm 127	Exhaust EC Controller (Air2ECxxx): High temperature (Thi)
128	B	10	N/A			Exhaust EC Controller (Air2ECxxx): High internal ripple voltage	Mains voltage unstable	Alarm 128	Exhaust EC Controller (Air2ECxxx): High internal ripple voltage
129	B	10	N/A			Supply EC Controller (Air2ECxxx): Lacking supply phase	Mains voltage lacks a phase	Alarm 129	Supply EC Controller (Air2ECxxx): Lacking supply phase
130	B	10	N/A			Exhaust EC Controller (Air2ECxxx): Lacking supply phase	Mains voltage lacks a phase	Alarm 130	Exhaust EC Controller (Air2ECxxx): Lacking supply phase
131	A	10	N/A	X	X	FanIO 1 (Air2FanIO21): No communication	FanIO not connected to bus in FanIO port A; fault in bus cable; FanIO DIP switch incorrectly set.	Alarm 131	FanIO 1 (Air2FanIO21): No communication
132	A	10	N/A	X	X	FanIO 2 (Air2FanIO21): No communication	FanIO not connected to bus in FanIO port A; fault in bus cable; FanIO DIP switch incorrectly set.	Alarm 132	FanIO 2 (Air2FanIO21): No communication
133	A	10	N/A	X	X	Damper actuator (supply), ID 130: No communication	Actuator not connected to bus. Error in bus cable. Address of actuator must be set to 130dec / 82hex.	Alarm 133	Damper actuator (supply), ID 130: No communication
134	A	10	N/A	X	X	Damper actuator (Exhaust), ID 131: No communication	Actuator not connected to bus. Error in bus cable. Address of actuator must be set to 131dec / 83hex.	Alarm 134	Damper actuator (Exhaust), ID 131: No communication
135	A	10	N/A	X	X	Damper actuator (Recirculation), ID 132: No communication	Actuator not connected to bus. Error in bus cable. Address of actuator must be set to 132dec / 84hex.	Alarm 135	Damper actuator (Recirculation), ID 132: No communication
136	A	10	N/A	X	X	Damper actuator (Heat exchanger), ID 133: No communication	Actuator not connected to bus. Error in bus cable. Address of actuator must be set to 133dec / 85hex.	Alarm 136	Damper actuator (Heat exchanger), ID 133: No communication
137	A	10	N/A	X	X	Damper actuator (Drying damper), ID 134: No communication	Actuator not connected to bus. Error in bus cable. Address of actuator must be set to 134dec / 86hex.	Alarm 137	Damper actuator (Drying damper), ID 134: No communication
138	A	10	N/A	X	X	Damper actuator (6) ID 135: No communication	Actuator not connected to bus. Error in bus cable. Address of actuator must be set to 135dec / 87hex.	Alarm 138	Damper actuator (6) ID 135: No communication
139	A	10	N/A	X	X	Damper actuator (Smoke evacuation damper) ID 136: No communication	Actuator not connected to bus. Error in bus cable. Address of actuator must be set to 136dec / 88hex.	Alarm 139	Damper actuator (Smoke evacuation damper) ID 136: No communication

Alarmlist, OJ-Air2 SW 6.30					WEB Text		HTERM Text		
Alarm-number	Alarm-type	Alarm-delay sec.	Alarm-Limit	Auto reset	Unit stop	WEB text	Pop-up text	Alarm number	Alarm text
140	A	10	N/A	X	X	Damper actuator (8) ID 137: Ingen Kommunikation	Actuator not connected to bus. Error in bus cable. Address of actuator must be set to 136dec / 88hex.	Alarm 140	Damper actuator (8) ID 137: No communication
141	A	10	N/A	X	X	Valve actuator (Heating1), ID 138: No communication	Actuator not connected to bus. Error in bus cable. Address of actuator must be set to 138dec / 8Ahex.	Alarm 141	Valve actuator (Heating), ID 138: No communication
142	A	10	N/A	X	X	Valve actuator (Cooling), ID 139: No communication	Actuator not connected to bus. Error in bus cable. Address of actuator must be set to 139dec / 8Bhex.	Alarm 142	Valve actuator (Cooling), ID 139: No communication
143	A	10	N/A	X	X	Valve actuator (Heating2), ID 140: No communication	Actuator not connected to bus. Error in bus cable. Address of actuator must be set to 140dec / 8Chex.	Alarm 143	Valve actuator (Heating2), ID 140: No communication
144	A	10	N/A	X	X	Valve actuator (Heat recovery), ID 141: No communication	Actuator not connected to bus. Error in bus cable. Address of actuator must be set to 141dec / 8Dhex.	Alarm 144	Valve actuator (Heat recovery), ID 141: No communication
145	A	10	N/A	X	X	Valve actuator (Preheater), ID 142: No communication	Actuator not connected to bus. Error in bus cable. Address of actuator must be set to 142dec / 8Ehex.	Alarm 145	Valve actuator (Preheater), ID 142: No communication
146	A	10	N/A	X	X	Valve actuator(Combi battery), ID 143: No communication	Actuator not connected to bus. Error in bus cable. Address of actuator must be set to 143dec / 8Fhex.	Alarm 146	Valve actuator(6), ID 143: No communication
147	A	10	N/A	X	X	Valve actuator (7) ID 144: No communication	Actuator not connected to bus. Error in bus cable. Address of actuator must be set to 144dec / 90hex.	Alarm 147	Valve actuator (7) ID 144: No communication
148	A	10	N/A	X	X	Valve actuator (8) ID 145: No communication	Actuator not connected to bus. Error in bus cable. Address of actuator must be set to 145dec / 91hex.	Alarm 148	Valve actuator (8) ID 145: No communication
149	B	10	N/A	X	X	Damper actuator (Supply): Can not reach the setpoint.	Please check if damper is stuck.	Alarm 149	Damper actuator (Supply): Can not reach the setpoint
150	B	10	N/A	X	X	Damper actuator (Exhaust): Can not reach the setpoint.	Please check if damper is stuck.	Alarm 150	Damper actuator (Exhaust): Can not reach the setpoint
151	B	10	N/A	X	X	Damper actuator (Recirculation): Can not reach the setpoint.	Please check if damper is stuck.	Alarm 151	Damper actuator (Recirculation): Can not reach the setpoint
152	B	10	N/A	X	X	Damper actuator (Heat exchanger): Can not reach the setpoint.	Please check if damper is stuck.	Alarm 152	Damper actuator (Heat exchanger): Can not reach the setpoint
153	B	10	N/A	X	X	Damper actuator (Drying damper): Can not reach the setpoint.	Please check if damper is stuck.	Alarm 153	Damper actuator (Drying damper): Can not reach the setpoint
157	B	10	N/A	X	X	Valve actuator (Heating1): Can not reach the setpoint.	Please check if valve is stuck.	Alarm 157	Valve actuator (Heating): Can not reach the setpoint
158	B	10	N/A	X	X	Valve actuator (Cooling): Can not reach the setpoint.	Please check if valve is stuck.	Alarm 158	Valve actuator (Cooling): Can not reach the setpoint
159	B	10	N/A	X	X	Valve actuator (Heating2): Can not reach the setpoint.	Please check if valve is stuck.	Alarm 159	Valve actuator (Heating2): Can not reach the setpoint
160	B	10	N/A	X	X	Valve actuator (Heatexchanger): Can not reach the setpoint.	Please check if valve is stuck.	Alarm 160	Valve actuator (Heatexchanger): Can not reach the setpoint
161	B	10	N/A	X	X	Valve actuator (Preheater): Can not reach the setpoint.	Please check if valve is stuck.	Alarm 161	Valve actuator (Preheater): Can not reach the setpoint
162	B	10	N/A	X	X	Valve actuator (Combi battery): G275	Please check if valve is stuck.	Alarm 162	Valve actuator (Combi battery): Can not reach the setpoint
163	B	10	N/A	X	X	Valve actuator (7): Can not reach the setpoint.	Please check if valve is stuck.	Alarm 163	Valve actuator (7): Can not reach the setpoint
164	B	10	N/A	X	X	Valve actuator (8): Can not reach the setpoint.	Please check if valve is stuck.	Alarm 164	Valve actuator (8): Can not reach the setpoint
166	B	10	N/A			Firedamper not closed	Alarm 166 activated	Alarm 166	Firedamper not closed
167	B	10	N/A			Firedamper not open	Alarm 167 activated	Alarm 167	Firedamper not open
168	B	300	N/A	X	X	Heating2 cut out due to low air volume	Air volume through electric heating battery too low for more than 5 minutes.	Alarm 168	Heating 2 cut out due to low air volume
169	B	30	N/A			Electric battery 2: overheating alarm	Overheat thermostat in electric heating battery 2 has cut out.	Alarm 169	Electric battery2: overheating alarm
170	B	30	N/A			Contactor for electric heating battery 2 stuck	Digital input "Heating battery 2 fault" activated when heating relay 21 open. Contactor burnt out.	Alarm 170	Contactor for electric heating battery 2 is stuck
171	A	10	N/A	X	X	Temperature sensor fault: Water battery 2	Water battery temp. sensor disconnected/short-circuited; sensor not configured for a temperature input	Alarm 171	Temperature sensor fault: Water battery 2
172	A	10	N/A	X	X	Pump alarm, heating 2	Digital input Heating battery 2 fault	Alarm 172	Pump alarm, Waterbattery 2
173	A	10	N/A	X	X	Frost alarm, water battery 2	Low flow temperature; defective circulation pump; low outdoor temperature	Alarm 173	Frost alarm, water battery 2
174	A	10	N/A	X	X	Temperature sensor fault: combi battery	Combi battery return water sensor disconnected/short-circuited; sensor not configured for a temperature input	Alarm 174	Temperature sensor fault: Combi battery
175	A	10	N/A	X	X	Pump alarm: combi battery	Digital input "Combi battery alarm" open Alarm from circulation pump	Alarm 175	Pump alarm: Combi battery
176	A	10	N/A	X	X	Combi battery heating frost alarm	Combi battery heating frost alarm	Alarm 176	Combi battery (Heating): Frostalarm
177	A	10	N/A	X	X	Combi battery cooling frost alarm	Combi battery cooling frost alarm	Alarm 177	Combi battery(cooling): Frostalarm
178	B	10	N/A	X	X	Alarm from heat recovery unit or circulation pump	Digital input "Heat recov. alarm" open or alarm from circulation pump	Alarm 178	Alarm from heatrecycling or circulationspump
179	B	10	N/A	X	X	Temperature sensor fault: heat pump	Air temp. sensor beside heat pump condenser disconnected/short-circuited; sensor not configured for a temperature input	Alarm 179	Temperature sensor fault: Heat pump
180	A	10	N/A	X	X	Frostalarm air	Frost thermostat tripped: Flow temperature low, Circulation pump error, outdoor temperature low.	Alarm 180	Frostalarm, air
181	B	10	N/A	X	X	Pressure sensor heatpump not configured (Only special customer:SW)	Pressure sensor for dynamic de-icing of heatpump is not configured	Alarm 181	Pressure sensor heatpump not configured
182	B	1200	N/A	X	X	Dynamic de-icing heatpump not measured (Only special customer:SW)	Dynamic de-icing heatpump not measured	Alarm 182	Dynamic de-icing heatpump not measured
183	B	10	N/A	X	X	Pressure sensor cross-flow heat exchanger not configured (Only special customer:SW)	Pressure sensor cross-flow heat exchanger not configured	Alarm 183	Pressure sensor cross-flow heat exchanger not configured
184	B	1200	N/A	X	X	Dynamic de-icing cross-flow heat exchanger not measured (Only special customer:SW)	Dynamic de-icing cross-flow heat exchanger not measured	Alarm 184	Dynamic de-icing cross-flow heat exchanger not measured

Alarmlist, OJ-Air2 SW 6.30				WEB Text		HTERM Text			
Alarm-number	Alarm-type	Alarm-delay sec.	Alarm-Limit	Auto reset	Unit stop	WEB text	Pop-up text	Alarm number	Alarm text
187	B	10	N/A			VVB cool/freeze, Pump Alarm (Only special customer SW)	VVB cool/freeze, Pump Alarm	Alarm 187	VVB cool/freeze, Pump Alarm
188	B	10	N/A	X		Temperature sensor fault: VVB cool/freeze, before condenser (Only special customer SW)	VVB cool/freeze temp. sensor disconnected/short-circuited; sensor not configured for a temperature input	Alarm 188	Temperature sensor fault: VVB cool/freeze, before condenser
189	B	10	N/A	X		Temperature sensor fault: VVB cool/freeze, after condenser (Only special customer SW)	Shunt battery temp. sensor disconnected/short-circuited; sensor not configured for a temperature input	Alarm 189	Temperature sensor fault: VVB cool/freeze, after condenser
190	B	10	N/A	X		Temperature sensor 1 fault: Room (Only special customer SW)	Room temp. sensor 1 disconnected/short-circuited	Alarm 190	Temperature sensor 1 fault: Room
191	B	10	N/A	X		Temperature sensor 2 fault: Room (Only special customer SW)	Room temp. sensor 2 disconnected/short-circuited	Alarm 191	Temperature sensor 2 fault: Room
192	A	10	N/A		X	Return water sensor error (Only special customer SW)	Return water sensor disconnected/short-circuited.	Alarm 192	Return water sensor error
193	B	10	N/A	X		Return water sensor is not configured (Only special customer SW)	Return water sensor is not configured.	Alarm 193	Return water sensor is not configured.
194	B	10	N/A	X		Humidity sensor (HTH6202): No communication	Humidity sensor (HTH6202): No communication	Alarm 194	No communication, Modbus, HTH-6202, sensor
195	B	10	N/A	X		Humidity sensor (HTH6203): No communication	Humidity sensor (HTH6203): No communication	Alarm 195	No communication, Modbus, HTH-6203, sensor
196	B	10	N/A	X		Output, humidifier, not configured	Output, humidifier, not configured	Alarm 196	Outputs ,humidifier not configured
197	B	10	N/A	X		Humidifier alarm	Alarm input from humidifier is active	Alarm 197	Alarm input from humidifier
198	B	1200	N/A	X		Supply humidity high	Supply humidity high	Alarm 198	Supply humidity high
199	B	1200	N/A	X		Supply humidity low	Supply humidity low	Alarm 199	Supply humidity low
200	B	1200	N/A	X		Extract humidity high	Extract humidity high	Alarm 200	Extract humidity high
201	B	1200	N/A	X		Extract humidity low	Extract humidity low	Alarm 201	Extract humidity low
202	B	10	N/A	X		Sensor error, Watercooling	Sensor error, Watercooling	Alarm 202	Sensor error, Watercooling
203	A	10	N/A	X	X	EXT.3: No communication	EXT.3: No communication	Alarm 203	EXT.3: No communication
204	A	10	N/A	X	X	EXT.4: No communication	EXT.4: No communication	Alarm 204	EXT.4: No communication
205	A	10	N/A	X	X	EXT.5: No communication	EXT.5: No communication	Alarm 205	EXT.5: No communication
206	A	10	N/A	X	X	EXT.6: No communication	EXT.6: No communication	Alarm 206	EXT.6: No communication
207	A	10	N/A	X	X	EXT.7: No communication	EXT.7: No communication	Alarm 207	EXT.7: No communication
208	B	10	N/A	X		Roomcontrol: No communication	Roomcontrol: No communication	Alarm 208	Roomcontrol: No communication
209	B	10	N/A	X		VOC Sensor: No communication	VOC Sensor: No communication	Alarm 209	VOC sensor: No communication
210	B	600	N/A	X		VOC sensor error, Measure value out of range	VOC sensor error, Measure value out of range	Alarm 210	VOC sensor: error Measure value out of range
211	B	10	N/A	X		Humidity sensor (HTH6204): No communication	Humidity sensor (HTH6204): No communication	Alarm 211	No communication, Modbus HTH-6204, sensor
212	B	10	N/A	X		Dewpoint sensor error	Dewpoint sensor error	Alarm 212	Dewpoint sensor error
213	B	300	N/A	X		Low efficiency heat exchanger	Low efficiency heat exchanger	Alarm 213	Low efficiency heat exchanger
214	A	10	N/A	X	X	EXT.8: No communication	EXT.8: No communication	Alarm 214	EXT.8: No communication
215	B	30	N/A			Contactor for preheater battery stuck	Contactor for preheater battery stuck	Alarm 215	Contactor for electric preheater battery stuck
216	B	30	N/A			Preheater: Overheating alarm	Preheater: Overheating alarm	Alarm 216	Preheater: Overheating alarm
217	A	10	N/A	X	X	Preheater, hotwater sensor error	Preheater, hotwater sensor error	Alarm 217	Preheater, Hotwater sensor error
218	A	10	N/A	X	X	Preheater, Pump alarm	Preheater, Pump alarm	Alarm 218	Preheater, Pump alarm
219	A	10	N/A	X	X	Preheater, Frost alarm	Preheater, Frost alarm	Alarm 219	Preheater, Frost alarm
220	A	10	N/A	X	X	Preheater, Air flow sensor error	Preheater, Air flow sensor error	Alarm 220	Preheater, Air flow sensor error
221	B	300	N/A	X		Preheater, Power reduced	Preheater, Power reduced	Alarm 221	Preheater, Power reduced
222	B	300	N/A	X		Heat recovery efficiency is lower than min. Setpoint	Heat recovery efficiency is lower than min. Setpoint	Alarm 222	Heat recovery efficiency is lower than min. Setpoint
223	A	10	N/A	X	X	Supply frequency conv. (ATV): No communication	ATV not connected to bus in FanIO port B	Alarm 223	Supply frequency converter (ATV) No communication
224	A	10	N/A	X	X	Exhaust frequency conv. (ATV): No communication	ATV not connected to bus in FanIO port B	Alarm 224	Exhaust frequency converter (ATV) No communication
225	A	10	N/A			Error, ATV supply frequency converter	An error occurred in the ATV supply frequency converter, more information through the ATV interface	Alarm 225	Error, ATV supply frequency converter
226	A	10	N/A			Error, ATV exhaust frequency converter	An error occurred in the ATV exhaust frequency converter, more information through the ATV interface	Alarm 226	Error, ATV exhaust frequency converter
227	A	10	N/A		X	Frostalarm - fluid coupled heat exchanger	Frostalarm - fluid coupled heat exchanger	Alarm 227	Frost alarm Fluid coupled heat exchanger
228	B	30	N/A			Contactor for electrical frostprotection battery stuck	Contactor for electrical frostprotection battery stuck	Alarm 228	Contactor for electrical frostprotection battery stuck
229	B	30	N/A			Electric frostprotection battery: overheating alarm	Electric frostprotection battery: overheating alarm	Alarm 229	Electrical frostprotection battery: Overheating alarm
230	B	300	N/A	X		Reduced frostprotection on electric frostprotection battery	Reduced frostprotection on electric frostprotection battery	Alarm 230	Reduced frostprotection on electrical frostprotection battery

Alarmlist, OJ-Air2 SW 6.30				WEB Text		HTERM Text			
Alarm- nummer	Alarm- type	Alarm- forsink sek.	Alarm- grænse	Auto reset	Anlægs stop	WEB text	Pop-up text	Alarm- nummer	Alarmtext
231	B	1200	N/A	X		De-icing pressure, rotating heatrecovery, not calibrated	De-icing pressure, rotating heatrecovery, not calibrated	Alarm 231	De-icing pressure, rotating heatrecovery, not calibrated. Dynamic pressure regulation cannot be used.
232	B	10	N/A	X		PTH-sensor (ETA/EHA), rotating heatrecovery, not configured	PTH-sensor (ETA/EHA), rotating heatrecovery, not configured	Alarm 232	PTH-sensor (ETA/EHA), rotating heatrecovery, not configured
233	B	1800	N/A	X		Rotating heat recovery frozen	Rotating heat recovery frozen	Alarm 233	Rotating heat exchanger is frozen
234	B	1800	N/A	X		Rotating heat recovery is soiled	Rotating heat recovery is soiled	Alarm 234	Rotating heat exchanger is soiled
235	A	10	N/A	X		Supply EC-2 Controller: Alarm stop	Supply EC-2 Controller: Alarm stop	Alarm 235	Supply EC-2 Controller : Alarm stop
236	A	10	N/A	X		Supply EC-2 Controller: Blocked rotor	Supply EC-2 Controller: Blocked rotor	Alarm 236	Supply EC-2 Controller : Blocked rotor
237	B	10	N/A			Supply EC-2 Controller: Current limit active	Supply EC-2 Controller: Current limit active	Alarm 237	Supply EC-2 Controller : Current limit active
238	B	10	N/A			Supply EC-2 Controller: Low Supply voltage (Vlo)	Supply EC-2 Controller: Low Supply voltage (Vlo)	Alarm 238	Supply EC-2 Controller :Low Supply voltage (Vlo)
239	B	10	N/A			Supply EC-2 Controller: High Supply voltage (Vhi)	Supply EC-2 Controller: High Supply voltage (Vhi)	Alarm 239	Supply EC-2 Controller : High Supply voltage (Vhi)
240	B	10	N/A			Supply EC-2 Controller: High temperature (Thi)	Supply EC-2 Controller: High temperature (Thi)	Alarm 240	Supply EC-2 Controller : High temperature (Thi)
241	B	10	N/A			Supply EC-2 Controller: High internal ripple voltage	Supply EC-2 Controller: High internal ripple voltage	Alarm 241	Supply EC-2 Controller : High internal ripple voltage
242	A	10	N/A	X		Exhaust EC-2 Controller: Alarm stop	Exhaust EC-2 Controller: Alarm stop	Alarm 242	Exhaust EC-2 Controller : Alarm stop
243	A	10	N/A	X		Exhaust EC-2 Controller: Blocked rotor	Exhaust EC-2 Controller: Blocked rotor	Alarm 243	Exhaust EC-2 Controller : Blocked rotor
244	B	10	N/A			Exhaust EC-2 Controller: Current limit active	Exhaust EC-2 Controller: Current limit active	Alarm 244	Exhaust EC-2 Controller : Current limit active
245	B	10	N/A			Exhaust EC-2 Controller: Low supply voltage (Vlo)	Exhaust EC-2 Controller: Low supply voltage (Vlo)	Alarm 245	Exhaust EC-2 Controller : Low supply voltage (Vlo)
246	B	10	N/A			Exhaust EC-2 Controller: High supply voltage (Vhi)	Exhaust EC-2 Controller: High supply voltage (Vhi)	Alarm 246	Exhaust EC-2 Controller : High supply voltage (Vhi)
247	B	10	N/A			Exhaust EC-2 Controller: High temperature (Thi)	Exhaust EC-2 Controller: High temperature (Thi)	Alarm 247	Exhaust EC-2 Controller : High temperature (Thi)
248	B	10	N/A			Exhaust EC-2 Controller: High internal ripple voltage	Exhaust EC-2 Controller: High internal ripple voltage	Alarm 248	Exhaust EC-2 Controller : High internal ripple voltage
249	B	10	N/A			Supply EC-2 Controller: Lacking supply phase	Supply EC-2 Controller: Lacking supply phase	Alarm 249	Supply EC-2 Controller : Lacking supply phase
250	B	10	N/A			Exhaust EC-2 Controller: Lacking supply phase	Exhaust EC-2 Controller: Lacking supply phase	Alarm 250	Exhaust EC-2 Controller : Lacking supply phase
251	A	10	N/A	X	X	Supply EC-2 Controller: No communication	Supply EC-2 Controller: No communication	Alarm 251	Supply EC-2 Contri: No communication
252	A	10	N/A	X	X	Exhaust EC-2 Controller: No communication	Exhaust EC-2 Controller: No communication	Alarm 252	Exhaust EC-2 Contrl: No communication
253	B	10	N/A			Temperature sensor (TTH-6202): No communication	Temperature sensor (TTH-6202): No communication	Alarm 253	Temperature sensor (TTH-6202): No communication
254	B	10	N/A			Temperature sensor (TTH-6203): No communication	Temperature sensor (TTH-6203): No communication	Alarm 254	Temperature sensor (TTH-6203): No communication
255	B	10	N/A			Supply airflow correction temperature sensor fault	Supply airflow correction temperature sensor fault	Alarm 255	Supply airflow correction temperature sensor fault
256	B	10	N/A	X		Temperature sensor fault: Addon sensor 1	Temperature sensor fault: Addon sensor 1	Alarm 256	Temperature sensor fault: Addon sensor 1
257	B	10	N/A	X		Temperature sensor fault: Addon sensor 2	Temperature sensor fault: Addon sensor 2	Alarm 257	Temperature sensor fault: Addon sensor 2
258	B	10	N/A	X		Temperature sensor fault: Addon sensor 3	Temperature sensor fault: Addon sensor 3	Alarm 258	Temperature sensor fault: Addon sensor 3
259	B	10	N/A	X		Temperature sensor fault: Addon sensor 4	Temperature sensor fault: Addon sensor 4	Alarm 259	Temperature sensor fault: Addon sensor 4
260	A	10	N/A		X	Supply controller 1 has the wrong type number or is defect	Replace controller 1	Alarm 260	Supply controller 1 has the wrong type no. or is defect
261	A	10	N/A		X	Supply controller 2 has the wrong type number or is defect	Replace controller 2	Alarm 261	Supply controller 2 has the wrong type no. or is defect
262	A	10	N/A		X	Discharge/exhaust controller 1 has the wrong type number or is defect	Replace controller 1	Alarm 262	Discharge/exhaust controller 1 has the wrong type number or is defect
263	A	10	N/A		X	Discharge/exhaust controller 2 has the wrong type number or is defect	Replace controller 2	Alarm 263	Discharge/exhaust controller 2 has the wrong type number or is defect
264	A	10	N/A	X	X	Room sensor (TTH-6040-W): No communication	Room sensor (TTH-6040-W): No communication	Alarm 264	Room sensor (TTH-6040-W): No communication
265	B	10	N/A	X		Low oil level in DX/HP cooling compressor	Low oil level in DX/HP cooling compressor	Alarm 265	Low oil level in DX/HP cooling compressor
266	A	10	N/A	X		Manual firemanstop	Manual firemanstop	Alarm 266	AHU stopped from the fire man
267	B	10	N/A	X		Bypass smoke evacuation is active with external fan	Bypass smoke evacuation is active with external fan	Alarm 267	Bypass smoke evacuation is active with external fan
268	B	10	N/A	X		Room temperature from BMS system is out of range	Room temperature from BMS system is out of range	Alarm 268	Room temperature from BMS is out of range
269	B	10	N/A	X		Outdoor temperature from BMS system is out of range	Outdoor temperature from BMS system is out of range	Alarm 269	Outdoor temperature from BMS is out of range
270	B	10	N/A	X		Smoke evacuation fan error: Motor did not start	Smoke evacuation fan error: Motor did not start	Alarm 270	Smoke evacuation fan error: Motor did not start
271	B	10	N/A	X		Change outdoor filter and reset timer	The pre defined time for change of outdoor filter is out - change filter and reset timer for filter change	Alarm 271	Change outdoor filter and reset the timer
272	B	10	N/A	X		Change extract filter and reset timer	The pre defined time for change of extract filter is out - change filter and reset timer for filter change	Alarm 272	Change extract filter and reset the timer

Alarmlist, OJ-Air2 SW 6.30					WEB Text			HTERM Text		
Alarm- nummer	Alarm- type	Alarm- forsink sek.	Alarm- grænse	Auto reset	Anlægs reset	stop	WEB text	Pop-up text	Alarm- nummer	Alarmtext
273	B	10	N/A	X	X		Supply air frequency inverter: Power reduction is activated	Supply air frequency inverter: Power reduction is activated	Alarm 273	Supply air frequency inverter: Power reduction is activated
274	B	10	N/A	X	X		Extract air frequency inverter: Power reduction is activated	Extract air frequency inverter: Power reduction is activated	Alarm 274	Extract air frequency inverter: Power reduction is activated
275	A	10	N/A	X	X		Supply air FC-DV Controller: Rotor blocked	Supply air FC-DV Controller: Rotor blocked	Alarm 275	Supply air FC-DV Controller: Rotor blocked
276	A	10	N/A	X	X		Extract air FC-DV Controller: Rotor blocked	Extract air FC-DV Controller: Rotor blocked	Alarm 276	Extract air FC-DV Controller: Rotor blocked
277	A	10	N/A	X	X		Supply air EC Controller (OJ-EC): High output current (Ith)	Short circuit in motor or cable, Rotor blocked, Wrong motor-type	Alarm 277	Supply air EC Controller (OJ-EC): High output current (Ith)
278	A	10	N/A	X	X		Extract air EC Controller (OJ-EC): High output current (Ith)	Short circuit in motor or cable, Rotor blocked, Wrong motor-type	Alarm 278	Extract air EC Controller (OJ-EC): High output current (Ith)
279	A	10	N/A	X	X		Supply air EC-2 Controller (OJ-EC): High output current (Ith)	Short circuit in motor or cable, Rotor blocked, Wrong motor-type	Alarm 279	Supply air EC-2 Controller (OJ-EC): High output current (Ith)
280	A	10	N/A	X	X		Extract air EC-2 Controller (OJ-EC): High output current (Ith)	Short circuit in motor or cable, Rotor blocked, Wrong motor-type	Alarm 280	Extract air EC-2 Controller (OJ-EC): High output current (Ith)
281	B	10	N/A				Supply air fan stopped (Special SW/customer code)	Supply air fan stopped (Special SW/customer code)	Alarm 281	Supply air fan stopped (Special SW/customer code)
282	A	10	N/A	X	X		HMI-20T communication error	HMI-20T communication error	Alarm 282	HMI-20T communication error
289	B	10	N/A				Smoke evacuation damper position error: Can not reach the setpoint.	Smoke evacuation damper position error: Can not reach the position	Alarm 289	Smoke evacuation damper position error: Can not reach the position
290	B	10	N/A				Bypass evacuation damper position error: Can not reach the setpoint.	Bypass evacuation damper position error: Can not reach the position	Alarm 290	Bypass evacuation damper position error: Can not reach the position
291	A	10	N/A	X	X		Alarm PTH-6202-2 #1 (#1 = Address switch in position 1)	Alarm PTH-6202-2 #1	Alarm 291	Alarm PTH-6202-2 #1
292	A	10	N/A	X	X		Alarm PTH-6202-2 #2 (#2 = Address switch in position 2)	Alarm PTH-6202-2 #2	Alarm 292	Alarm PTH-6202-2 #2
293	A	10	N/A	X	X		Alarm PTH-6202-2 #3 (#3 = Address switch in position 3)	Alarm PTH-6202-2 #3	Alarm 293	Alarm PTH-6202-2 #3
294	A	10	N/A	X	X		Alarm PTH-6202-2 #4 (#4 = Address switch in position 4)	Alarm PTH-6202-2 #4	Alarm 294	Alarm PTH-6202-2 #4
295	A	10	N/A	X	X		Alarm PTH-6202-2 #5 (#5 = Address switch in position 5)	Alarm PTH-6202-2 #5	Alarm 295	Alarm PTH-6202-2 #5
296	B	600	N/A				Supply filter 2 - alarm	Supply filter 2 - alarm	Alarm 296	Supply filter 2 - alarm
297	B	600	N/A				Exhaust filter 2 - alarm	Exhaust filter 2 - alarm	Alarm 297	Exhaust filter 2 - alarm
298	B	10	N/A	X	X		Supply filter 2 - timer runout alarm	Supply filter 2 - timer runout alarm	Alarm 298	Supply filter 2 - timer runout alarm
299	B	10	N/A	X	X		Exhaust filter 2 - timer runout alarm	Exhaust filter 2 - timer runout alarm	Alarm 299	Exhaust filter 2 - timer runout alarm
300	B	30	N/A				Alarm from gasheater1, over heating	Alarm from gasheater1, over heating	Alarm 300	Alarm from gasheater1, over heating
301	B	30	N/A				Alarm from gasheater2, over heating	Alarm from gasheater2, over heating	Alarm 301	Alarm from gasheater2, over heating
302	B	30	N/A				Alarm from gas pre-heater, over heating	Alarm from gas pre-heater, over heating	Alarm 302	Alarm from gas pre-heater, over heating
303	B	10	N/A	X	X		Zone Module no. 1 communication error	Zone Module no. 1 communication error	Alarm 303	Zone Module no. 1 communication error
304	B	10	N/A	X	X		Zone Module no. 2 communication error	Zone Module no. 2 communication error	Alarm 304	Zone Module no. 2 communication error
305	B	10	N/A	X	X		Zone Module no. 3 communication error	Zone Module no. 3 communication error	Alarm 305	Zone Module no. 3 communication error
306	B	10	N/A	X	X		Zone Module no. 4 communication error	Zone Module no. 4 communication error	Alarm 306	Zone Module no. 4 communication error
307	B	10	N/A	X	X		Zone 1 - at least one active alarm	Zone 1 - at least one active alarm	Alarm 307	Zone 1 - at least one active alarm
308	B	10	N/A	X	X		Zone 2 - at least one active alarm	Zone 2 - at least one active alarm	Alarm 308	Zone 2 - at least one active alarm
309	B	10	N/A	X	X		Zone 3 - at least one active alarm	Zone 3 - at least one active alarm	Alarm 309	Zone 3 - at least one active alarm
310	B	10	N/A	X	X		Zone 4 - at least one active alarm	Zone 4 - at least one active alarm	Alarm 310	Zone 4 - at least one active alarm
311	B	10	N/A	X	X		Temperature sensor fault: Heat recovery sensor	Temperature sensor fault: Sensor disconnected/short-circuited	Alarm 311	Temperature sensor fault: Heat recovery sensor
312	B	10	N/A	X	X		CVM Mini Meter: Communication error	CVM Mini Meter: Communication error	Alarm 312	CVM Mini Meter: Communication error
313	B	10	N/A	X	X		CVM Cool Mini Meter: Communication error	CVM Cool Mini Meter: Communication error	Alarm 313	CVM Cool Mini Meter: Communication error
314	A	10	N/A	X	X		Extension module45 3 (Air2Ext45): No communication	Air2 Ext45 #3 not connected to bus	Alarm 314	Extension module45 #3 (Air2Ext45): No communication
315	B	10	N/A	X	X		Ext. outdoor sensor (TTH-6040-O): No communication	Ext. outdoor sensor (TTH-6040-O): No communication	Alarm 315	Ext. outdoor sensor (TTH-6040-O): No communication
316	A	10	N/A	X	X		Belimo Exhaust Backup damper: No communication	Belimo Exhaust Backup damper: No communication	Alarm 316	Belimo Exhaust Backup damper: No communication
317	B	10	N/A	X	X		Belimo Exhaust Backup damper position error: Can not reach the position	Belimo Exhaust Backup damper position error: Can not reach the position	Alarm 317	Belimo Exhaust Backup damper position error: Can not reach the position
318	A	10	N/A	X	X		Belimo Supply Backup damper: No communication	Belimo Supply Backup damper: No communication	Alarm 318	Belimo Supply Backup damper: No communication
319	B	10	N/A	X	X		Belimo Supply Backup damper position error: Can not reach the position	Belimo Supply Backup damper position error: Can not reach the position	Alarm 319	Belimo Supply Backup damper position error: Can not reach the position
320	B	10	N/A	X	X		Alarm from Fan Wall - Supply	Alarm from Fan Wall - Supply	Alarm 320	Alarm from Fan Wall - Supply
321	B	10	N/A	X	X		Alarm from Fan Wall - Extract/Exhaust	Alarm from Fan Wall - Extract/Exhaust	Alarm 321	Alarm from Fan Wall - Extract/Exhaust
323	A	10	N/A	X	X		Pressure sensor 8 (PTH6202): No communication	Pressure sensor 8 (PTH6202): No communication	Alarm 323	Pressure sensor 8 (PTH6202): No communication

Communication via external Modbus RTU / RS485

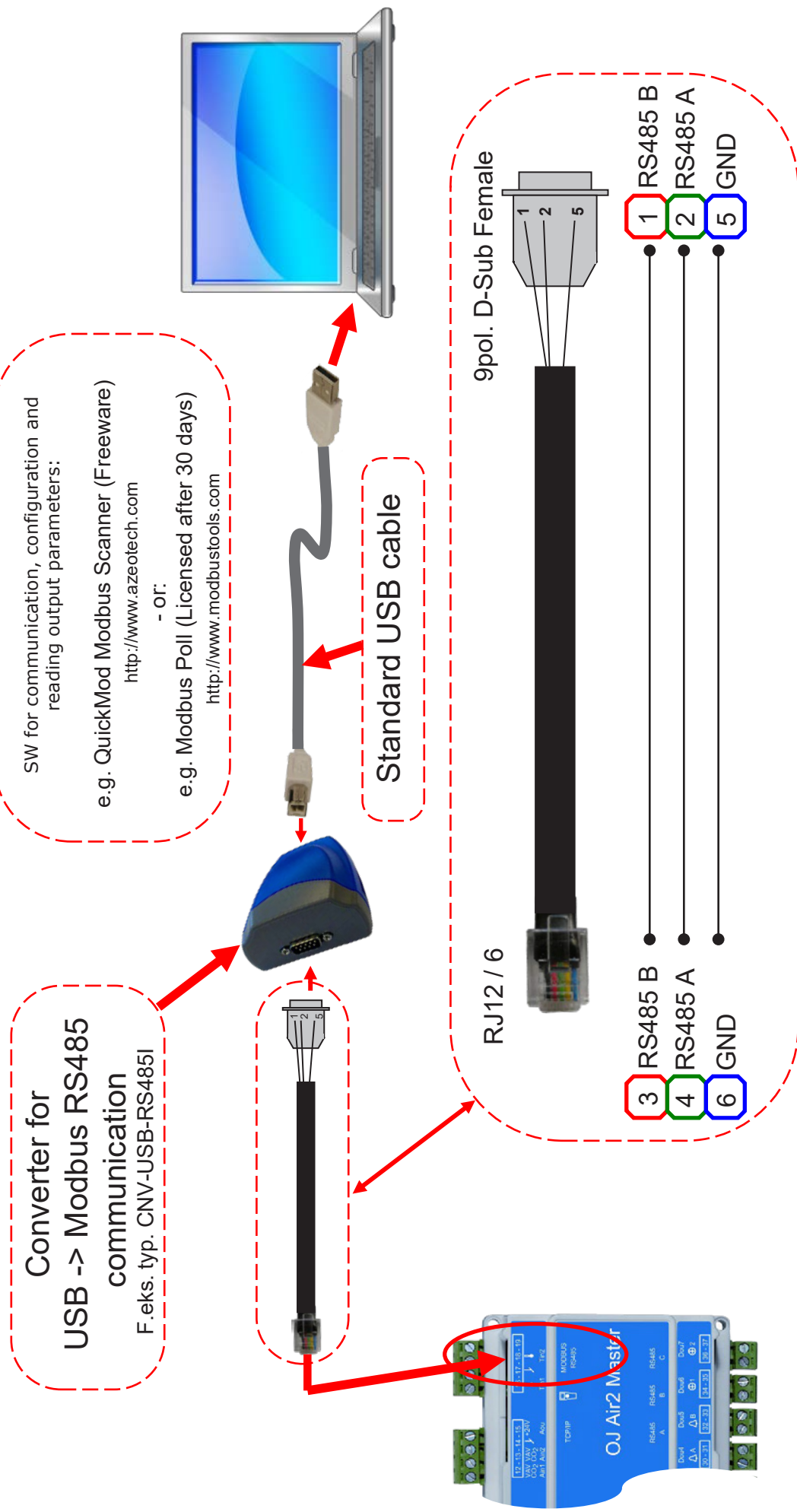

Communication via external Modbus RTU / RS485 – continued...

Setting the parameters for communication between OJ Air2 Master and DAQFactory

1. Start "DAQFactory QuickMod" Modbus Scanner

2. Click "Modbus RTU Serial"

3. Click "Configure"

4. Readout / Set communication parameters in OJ Air2 handterminal

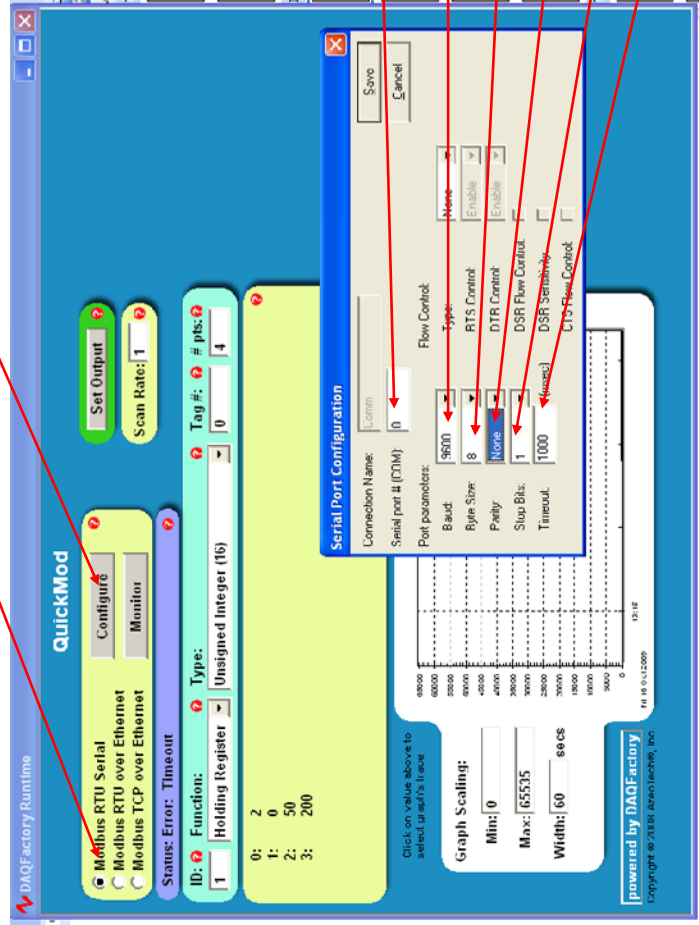

5. Set communication parameters in "DAQFactory QuickMod Modbus scanner"

6. Set "Serial port #" (COM) (Defined at Windows)

7. Set "Baudrate" as readout/set in OJ Air2 handterminal

8. Set "Byte Size = 8"

9. Set Parity = "None" as set in OJ Air2 handterminal

10. Set "Stop Bits" = 1 as set in OJ Air2 handterminal

11. Set "Timeout" = 1000

12. Click "Save"

Communication via external Modbus RTU / RS485 – continued...

SW for communication, configuration and reading output parameters:
e.g. QuickMod Modbus Scanner (Freeware)
<http://www.azeotech.com>
- Or:
e.g. Modbus Poll (Licensed after 30 days)
<http://www.modbustools.com>

Standard LAN cable

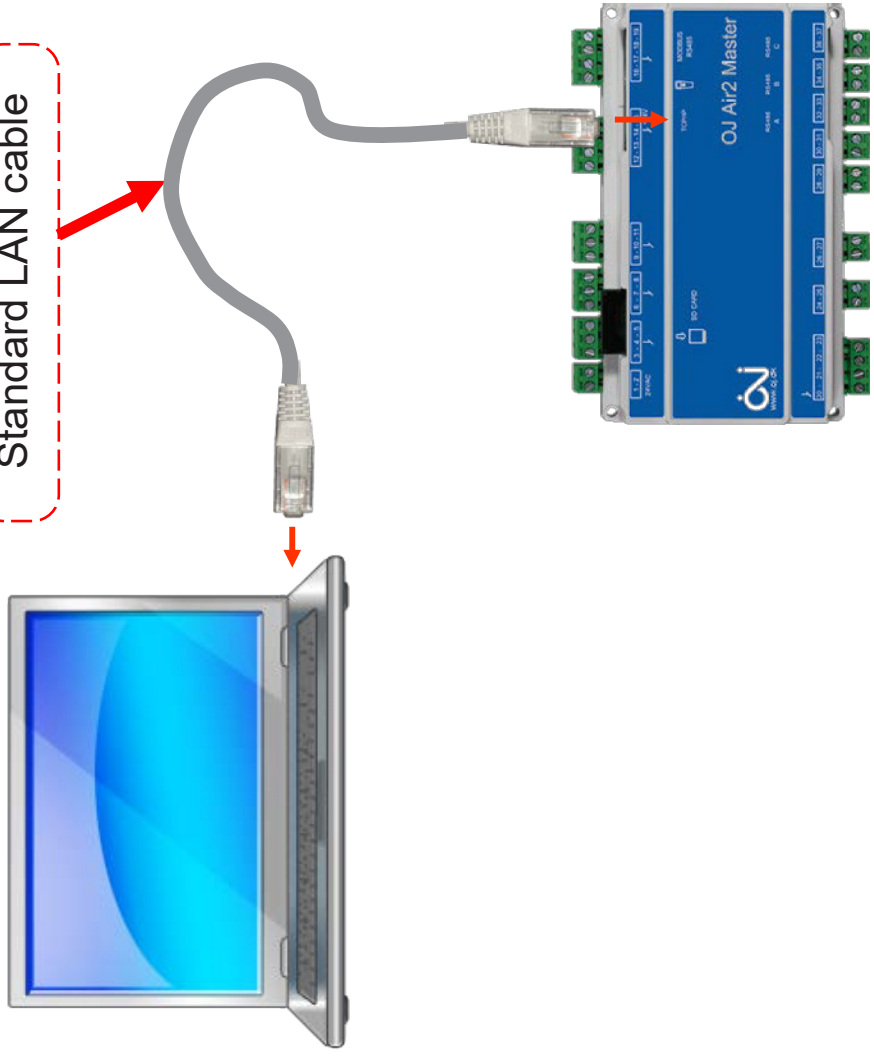

Communication via external Modbus RTU / RS485 – continued...

Setting the parameters for communication between OJ Air2 Master and DAQFactory

1. Start "DAQFactory QuickMod Modbus Scanner"

2. Click "Modbus TCP over Ethernet"

3. Click "Configure"

4. Readout / Set communication parameters i OJ Air2 handterminal

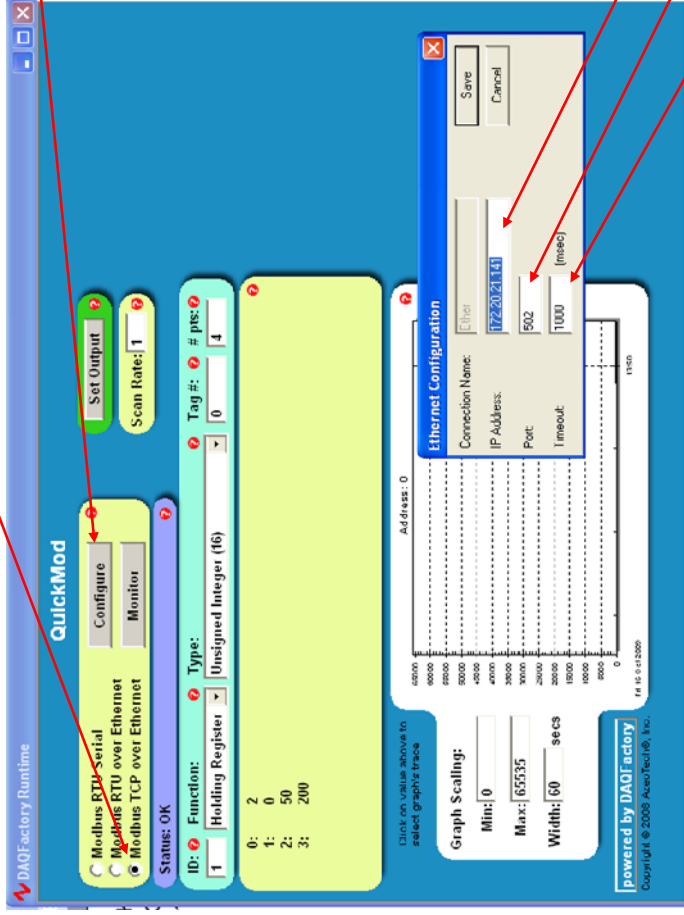

5. Set communication parameters in "DAQFactory QuickMod" Modbus Scanner

6. Set IP-Address as readout/set in OJ Air2 handterminal

7. Set Port = Always Port 502

8. Set "Timeout" = 1000

9. Click "Save"

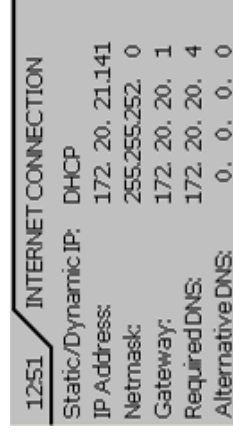
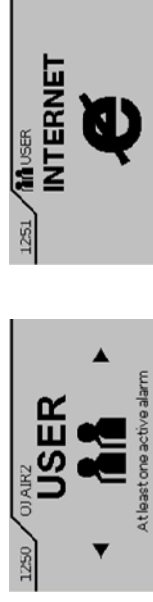

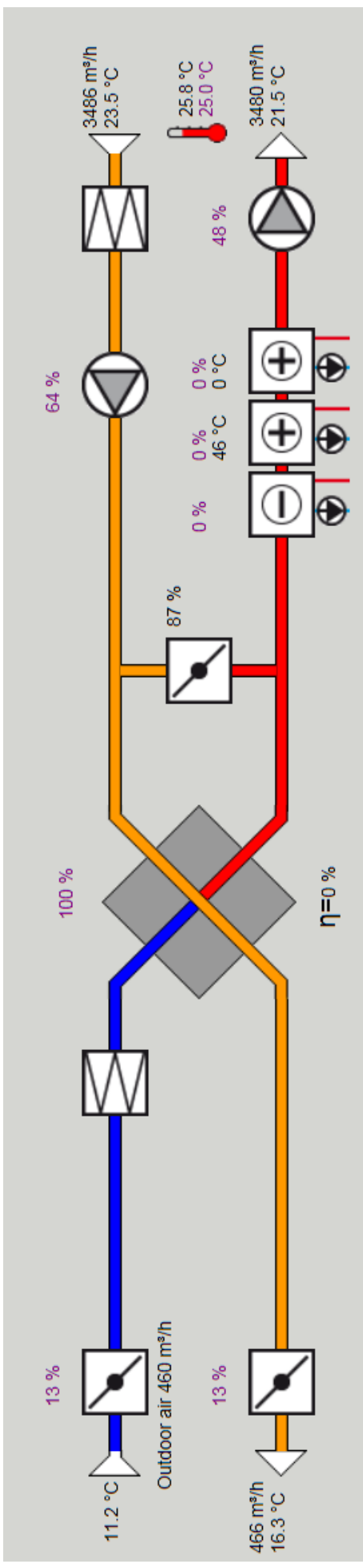

Temperature Control Sequence

